

STIMEX



Detail of the Libro frame.

A new folding tables era

Mobility and personalization are the key elements to promote efficiency and well-being in the workplace.

Argo is a collection of multifunctional and space-saving tables featuring robustness and stability while evoking elegance and lightness.

The handling and stacking of these tables allow the optimization of the spaces making them perfect for offices, conference rooms, catering but also for the home.

Mobilità e personalizzazione sono gli elementi chiave per promuovere l'efficienza e il benessere negli spazi di lavoro.

Argo è una collezione di tavoli salvaspazio verticalizzabili, ribaltabili e pieghevoli che offre un supporto stabile e robusto evocando eleganza e leggerezza.

La movimentazione e l'accatastamento dei tavoli permettono l'ottimale sfruttamento degli spazi, rendendoli perfetti per uffici, sale conferenza, per la ristorazione ma anche per la casa.

LIBRO

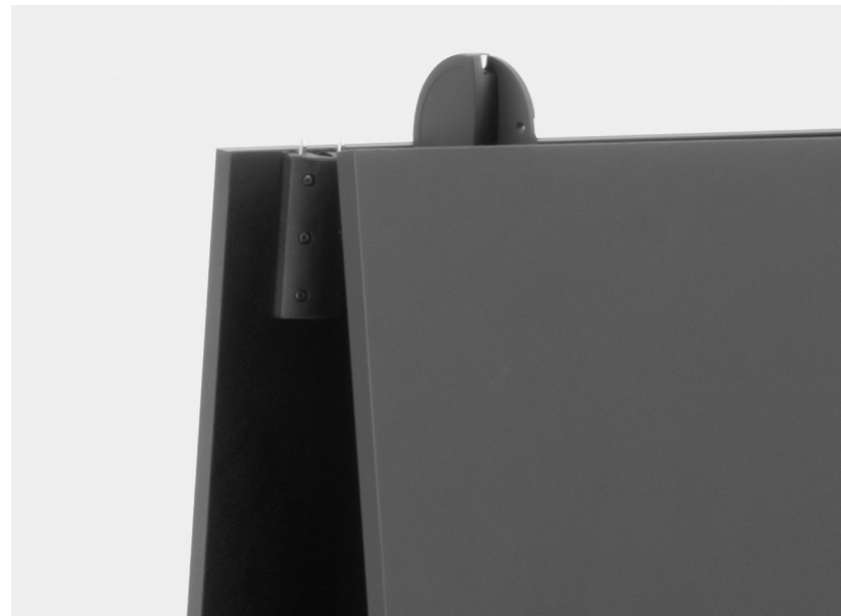

Libro (286L) multifunctional and space saving table ideal to be used in offices, conference rooms but also in residential contexts.

Detail of Libro with black frame and black FENIX tops.

TABLES AND DESKS / TAVOLI E SCRIVANIE



Libro XL (286XL) with black frames and FENIX tops with round corners.

Icon (7000) with Kvadrat (Remix 3) fabrics, and black frames.

LIBRO



Libro is equipped with the patented anti-shock system: the opening and closing of the table top is absolutely hands-safe and extremely simple.

An exclusive locking system allows the closure and the tops alignment.

TABLES AND DESKS / TAVOLI E SCRIVANIE

Libro (286L) with eco chromed frame and anthracite laminate tops.



LIBRO



TABLES AND DESKS / TAVOLI E SCRIVANIE



Libro (286T) with black elliptical tops and black powder coated frame.

Libro (286T) with black elliptical tops and black powder coated frame.

Loto Recycled (335L) with rose shell upholstered in Gabriel (Step Melange) fabric. Light grey powder coated sled frame.



B302 modular bookcase (500) in red finish.

Loto Recycled (335L) with rose shells and steel sled frames in light grey and red finish.

Front upholstered shell (3009) in Gabriel (Step Melange) fabric.

TILTING

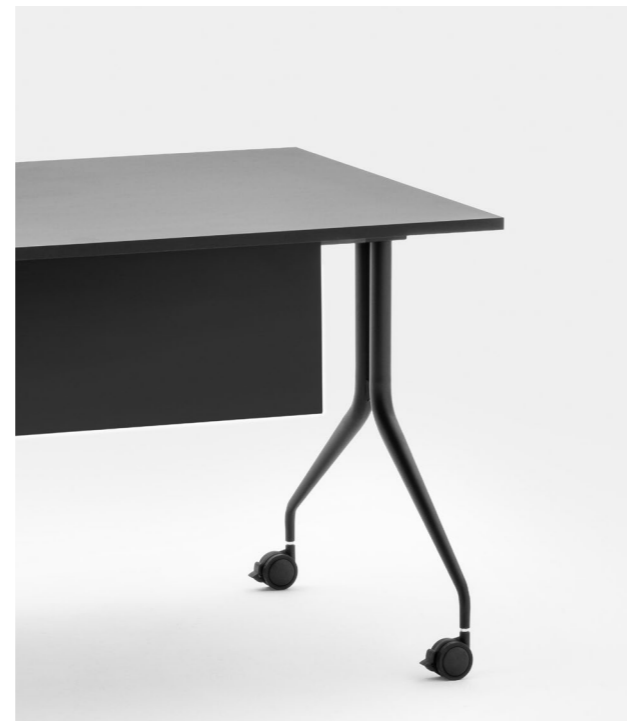

Tilting (206R) with black powder coated frame and laminate top.

The table can be enriched with a steel modesty panel.

TABLES AND DESKS / TAVOLI E SCRIVANIE



Tilting (206R) with eco chromed frames and anthracite laminate tops.

B302 Bench (500DBENCH),
a versatile and flexible soft
occasional seating in black finish
with upholstered cushion in Pugi
(Fenice) fabric.



Tilting (206R) with black powder
coated frames and FENIX tops.

Vea sled armchair (5150) with
upholstered seat and back in Pugi
(Fenice) fabric.



FOLDING / FIXED



Folding (206P) with black legs and white laminate top.

TABLES AND DESKS / TAVOLI E SCRIVANIE



Argo Fixed (206F) with black frame and FENIX top.

The double conical steel leg is enriched by functional contrasting feet that evoke elegance and lightness.

LIBRO

286 Small / 286 Large

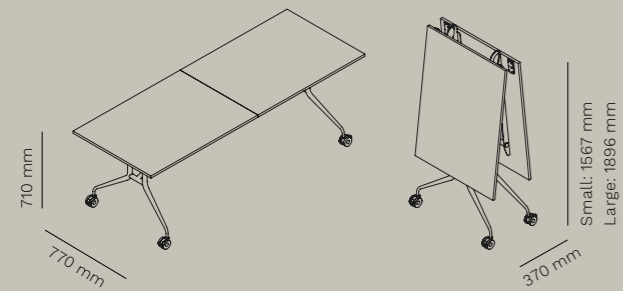

top
Small: 2000/2600 x 800/1000 mm
Large: 2800/3200 x 800/1000 mm

LIBRO XL

286XL Small / 286XL Large

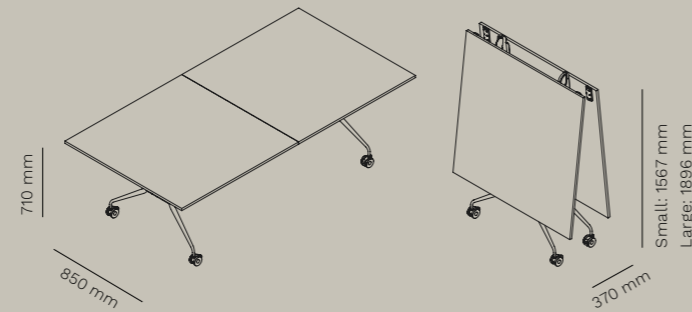

top
Small: 2000/2600 x 900/1200 mm
Large: 2800/3200 x 900/1200 mm

LIBRO

286T Round / 286T Elliptical

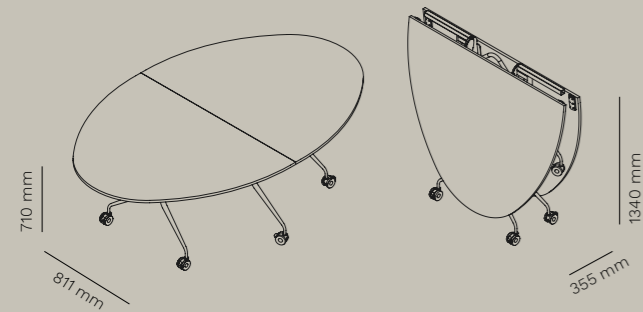

top
Round: Ø 1600/1800 mm
Elliptical: 1500 x 2400 mm

TILTING

206R

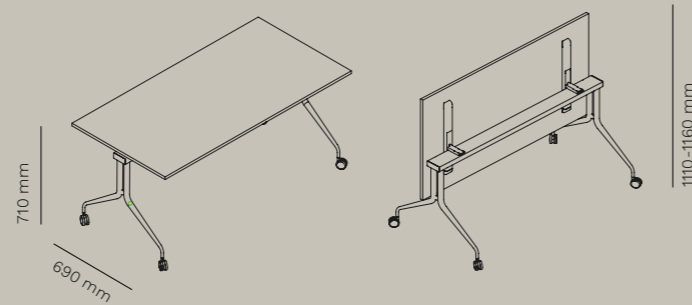

top
700/2000 x 700/800 mm

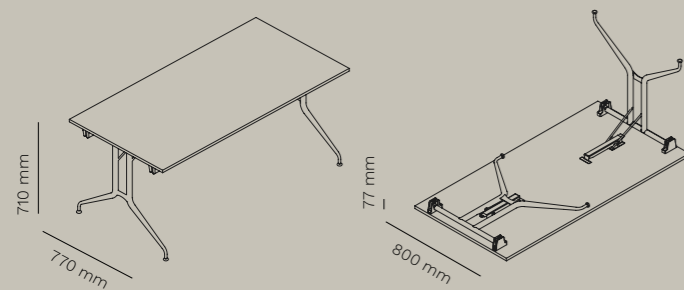
FOLDING 206P

top
1400/2000 x 800 mm

FIXED

206F

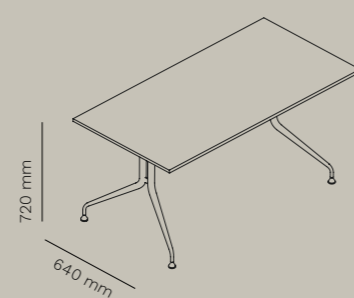

top
1400/2000 x 700/800 mm

DESCRIPTION / DESCRIZIONE

en Double leg entirely made with round tapered steel tube, sturdy and stable, available both powder coated in different finishes or chromed. Argo collection includes the Libro version (with integrated patented anti-shock system), the tilting version with folding top, the version with folding legs and the fixed version.

it Doppia gamba interamente in acciaio conificato e curvato, robusta e stabile, disponibile verniciata in diverse finiture o cromata. La collezione Argo comprende la versione Libro (con sistema antishock integrato e brevettato), la versione Tilting, con piano ribaltabile, quella con gambe pieghevoli e la versione fissa.

FEATURES / CARATTERISTICHE

**patented
system**
sistema
brevettato



certified
certificato



**stackable
versions**
versioni
impilabili

CERTIFICATIONS / CERTIFICAZIONI

UNI EN 15372:2016
(art. 286, 206R)

COLLECTION

TABLES AND DESKS / TAVOLI E SCRIVANIE

ACCESSORIES / ACCESSORI

511PLUS



top access with flip cover
passacavi con sportello

511EPLUS



top access with multifunctional sockets
passacavi con prese multifunzione

PASD60



multifunctional sockets
Ø 60 mm
prese multifunzione
Ø 60 mm

PASD80



multifunctional sockets
with wireless charging
Ø 80 mm
prese multifunzione con
ricarica wireless Ø 80 mm

299FP

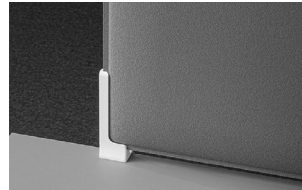

sound-absorbing panel
pannello fonoassorbente

215KIT



nylon kit for connection
agganci in nylon

8001



hanging cpu holder
portaserver pensile

300



cpu holder
portaserver

200



trolley
carrello

only for art. 206P
solo per art. 206P

206FR



modesty panel
pannello frontale

only for art. 206R
solo per art. 206R

206RV



cable tray
vasca porta cavi

only for art. 206R
solo per art. 206R

206BS

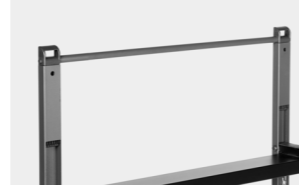

release bar
barra di sblocco

only for art. 206R
solo per art. 206R

KITPIEDI



feet for fixed version
piede per versione fissa

only for art. 206R
solo per art. 206R

206



plastic blocks with reinforcement metal bars
blocchetti con travi di rinforzo in metallo

only for art. 206P
solo per art. 206P

FRAME / STRUTTURA

powder coated steel
acciaio verniciato



296 textured raggrinzato RAL 9010	235 textured raggrinzato RAL 7035	301 textured raggrinzato RAL 7044	333 textured raggrinzato	131 textured raggrinzato RAL 9006
148 textured raggrinzato RAL 7016	120 textured raggrinzato RAL 9005	100 smooth liscio RAL 9006	116 semi-glossy semilucido RAL 9005	

chromed steel
acciaio cromato



eco chrome
cromo ecologico

TOP / PIANO

standard colour and material effect laminate tops
piani standard in laminato colore ed effetto materico



white bianco	magnolia	light grey grigio chiaro	anthracite antracite	black nero
whitened oak rovere sbiancato	natural oak rovere naturale	grey olm olmo grigio	black oak rovere nero	walnut noce
white marble marmo bianco	grey marble marmo grigio	graphite marble marmo grafite	black marble marmo nero	
rose	yellow giallo	light blue azzurro	green verde	

standard colour and wood melamine tops
piani standard in nobilitato colore e legno



white bianco	magnolia	light grey grigio chiaro	anthracite antracite	black nero
whitened oak rovere sbiancato	natural oak rovere naturale	grey olm olmo grigio	black oak rovere nero	walnut noce

standard FENIX tops
piani standard in FENIX

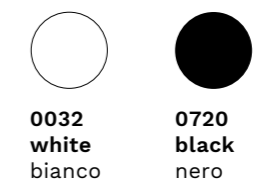

0032 white bianco	0720 black nero
-------------------------	-----------------------

Tables systems overview

HEIGHT ADJUSTABLE
ALTEZZA REGOLABILE

FOLLOW
DESK / 299F

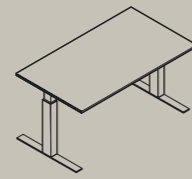

FOLLOW
BENCH / 299B

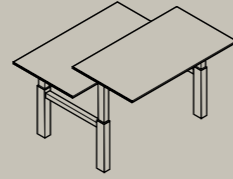

FOLLOW TILTING
/ 299R

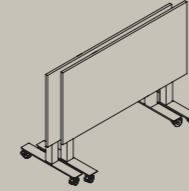

FOLLOW ME
/ 299E

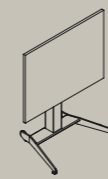

FOLLOW MEETING
/ 299M

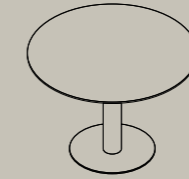

FOLLOW MEETING
LARGE / 298ML

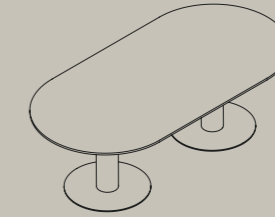

FOLLOW MEETING
CONE / 299MC

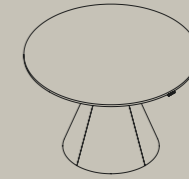

FOLLOW BREAK
/ 299K



LIBRO FOLDING
CHIUSURA A LIBRO

ARGO LIBRO
/ 286

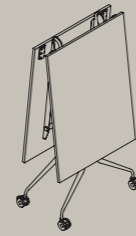

ARGO LIBRO XL
/ 286XL

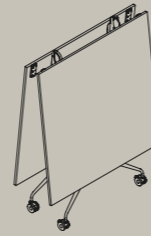

ARGO LIBRO
ELLIPTICAL /
286T



ARGO LIBRO
ROUND / 286T

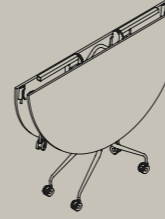

TIMMY LIBRO
/ 294L

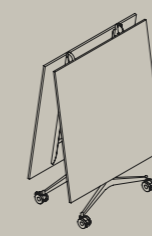

TIMMY LIBRO
H1050 / 294H

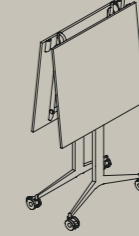

SAVIO LIBRO
COMPACT / 277L



TILTING TOP
PIANO RIBALTABILE

FOLLOW TILTING
/ 299R

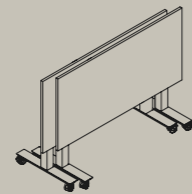

FOLLOW ME
299E

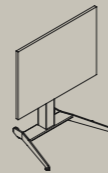

ARGO TILTING
/ 206R



TIMMY TILTING
/ 215R

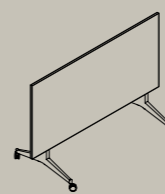

TIMMY TILTING
H1050 / 215RH

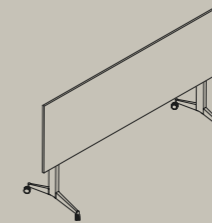

SAVIO TILTING
/ 227R

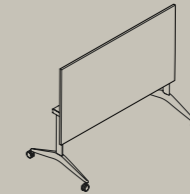

228 TILTING
/ 228R

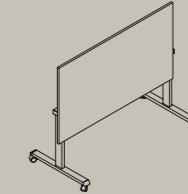

GATE TRAINING
/ 288

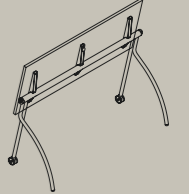

FOLDING LEGS
GAMBE PIEGHEVOLI

ARGO FOLDING
/ 206P

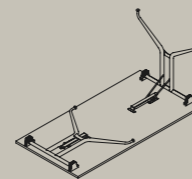

SAVIO FOLDING
/ 227P

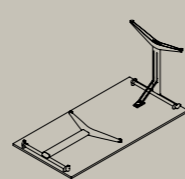

TIMMY FOLDING
/ 215P

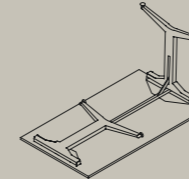

TIMMY PLUS
/ R0

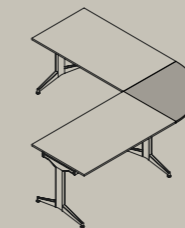

TIMMY PLUS
/ R400

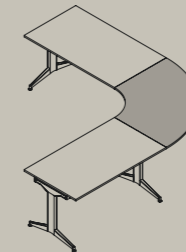

TIMMY PLUS
/ 1400, 1800

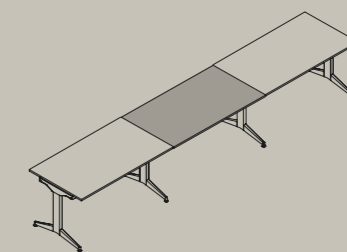

Height-adjustable tables, Libro folding and tilting tops tables, on castors and folding legs, in different sizes and shapes to design and furnish hybrid and dynamic spaces that respond to the changing needs of public and private contexts.

Tavoli regolabili in altezza, con chiusura a libro, con piani ribaltabili, su ruote, e con gambe pieghevoli, dalle diverse forme e dimensioni, per creare ed arredare spazi ibridi e dinamici in grado di rispondere alle mutevoli esigenze sia in contesti pubblici che privati.

DESKS
SCRIVANIE

FOLLOW DESK
/ 299F

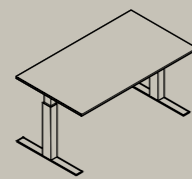

FOLLOW BENCH
/ 299B

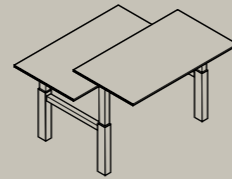

FIFTY 50
DESK / 214D

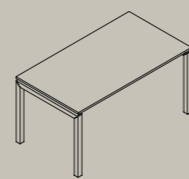

FIFTY 50
BENCH / 214B

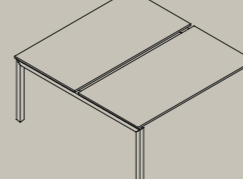

ARGO FIXED
/ 206F



TIMMY FIXED
/ 215F



MORGAN
/ 224

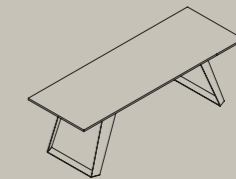

209 / 210
/ 209, 210

