



**ICON** SIMONE MICHELI

PREVIEW2017-02



STIMEX



"Desidero modellare spazi inediti, forme nuove, attraversare territori ed aree di pensiero non ancora note, per offrire all'uomo che si interfaccia con le mie opere frammenti di visioni future che, con energia e dinamismo, squarciano la patina opaca di quotidianità e scardinano i convenzionali stereotipi progettuali. L'evoluzione dei luoghi dedicati al business irrompe nella panoramica attuale di uffici ed aree-lavoro, dando origine a spazi nuovi, creativi, aperti, di cui lo scambio, le sinergie e l'interazione umana divengono il fulcro vitale. ICON prende vita dal desiderio di ripensare il concetto di area-office rendendola smart, innovativa, aperta e densa di segni significanti diversi"

Simone Micheli

"I want to sculpt unprecedented spaces, new forms, traversing previously unknown territories and thought patterns, to offer those who interface with my creations fragments of future visions that, with energy and dynamism, break through the dull patina of everyday life, shattering the conventional design stereotypes. The evolution of places dedicated to business breaks into the current state of office and workspace, giving rise to new, creative, open spaces, where exchange, synergy and human interaction are at the centre. ICON was born from the desire to rethink the office space concept, making it smart, innovative, open, and rich in varied significance"

"Ce que je veux, c'est façonner des espaces inédits, des formes nouvelles, traverser des territoires et des domaines de la pensée encore inexplorés. À qui s'interface avec mes réalisations, je veux montrer l'aperçu d'un futur décollant énergiquement l'opacité de la patine quotidienne et démantant l'esquisse des stéréotypes conceptuels qui navigue sur un flot de procédés conventionnels. L'évolution des lieux de travail se répand dans le panorama actuel de bureaux et autres zones d'activité, faisant naître des espaces nouveaux, créatifs et ouverts, dont la clé de voûte est faite d'échanges, de synergies et d'interactions humaines. C'est le désir de repenser le concept d'espace bureau qui insuffle à ICON la vie grâce à laquelle ces lieux se métamorphosent en espaces intelligents, innovants, ouverts et gorgés d'une multitude d'éloquentes perceptions"

# ICON

ICON è una collezione contemporanea, fluida, volta alla creazione di connessioni vitali con l'ambiente circostante e con l'uomo che vi interagisce. Caratterizzata da un'identità forte si contraddistingue per i tratti definiti, i colori chiari, le sue fluidità e gli effetti lucidi, opachi e preziosi dettati dai contrasti e dalle variazioni tra i multipli materiali. ICON rappresenta un ripensamento globale del concept concesso alla dimensione dell'ufficio, un ritratto innovativo delle direzioni che questo intrigante settore sta intraprendendo.

ICON is a contemporary, fluid collection designed to create vital connections with the surrounding environment and with your interaction counterparts. Characterised by a strong identity, it is distinguished by its strong lines, its light colours, its fluidity, and the glossy, opaque, high-end finishes dictated by the contrasts and variations between multiple materials. ICON represents a global reflection on the office dimension, an innovative portrait of the direction this intriguing industry is taking.

ICON est une collection contemporaine, fluide, qui s'applique à créer des liens profonds avec l'espace alentour et avec l'homme qui y interagit. Caractérisée par une identité forte, ICON est une succession de lignes définies, de contours fluides, ainsi que de couleurs claires, tantôt brillantes, tantôt mates et précieuses, dictées par les contrastes et les variations entre de nombreux matériaux. ICON représente un revirement global du concept attribué à la dimension du milieu de travail, un portrait innovant des directions que ce fascinant secteur est en train d'amorcer.







Caratterizzata da un'identità forte  
si contraddistingue per i tratti definiti,  
i colori chiari, le sue fluidità  
e gli effetti lucidi, opachi  
e preziosi dettati dai contrasti  
e dalle variazioni tra i multipli materiali.

Characterised by a strong identity,  
it is distinguished by its strong lines,  
its light colours, its fluidity,  
and the glossy, opaque, high-end  
finishes dictated by the contrasts  
and variations between  
multiple materials.

Caractérisée par une identité forte,  
ICON est une succession  
de lignes définies, de contours fluides,  
ainsi que de couleurs claires,  
tantôt brillantes, tantôt mates  
et précieuses, dictées par les  
contrastes et les variations entre  
de nombreux matériaux.



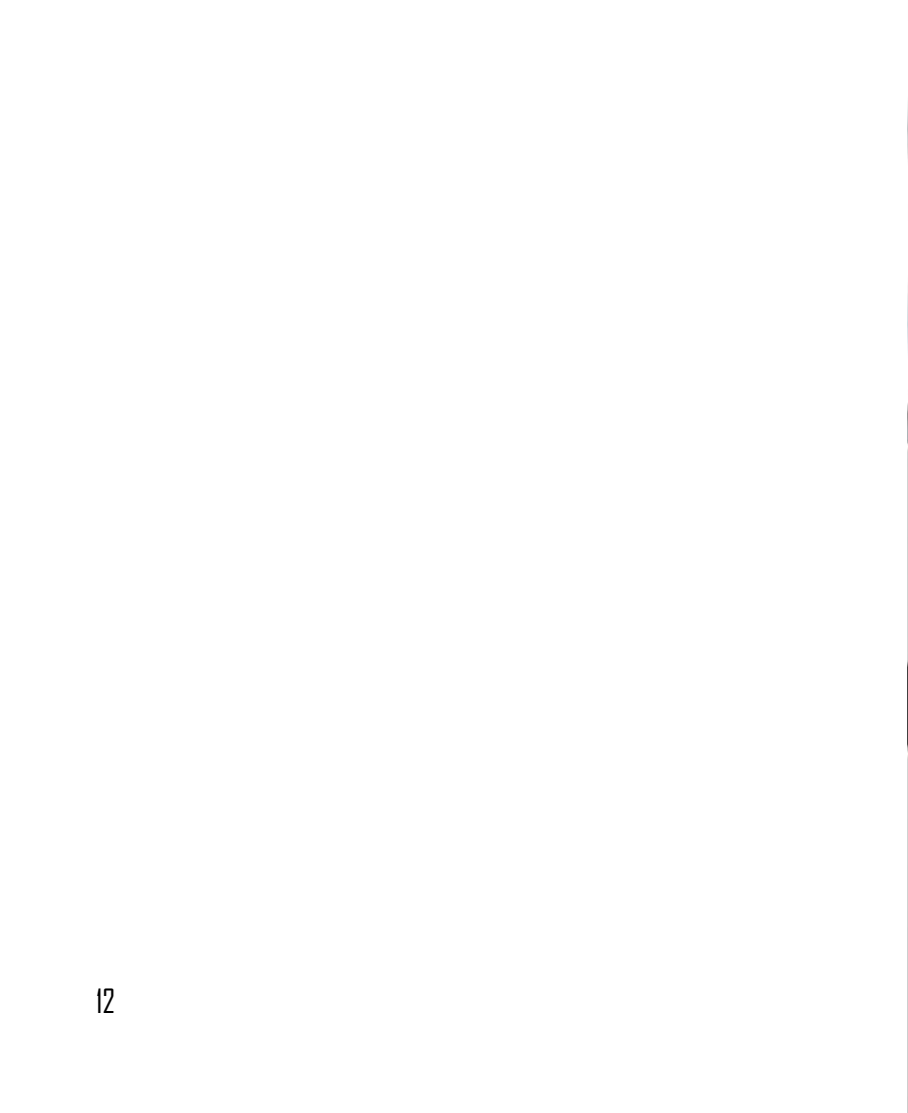
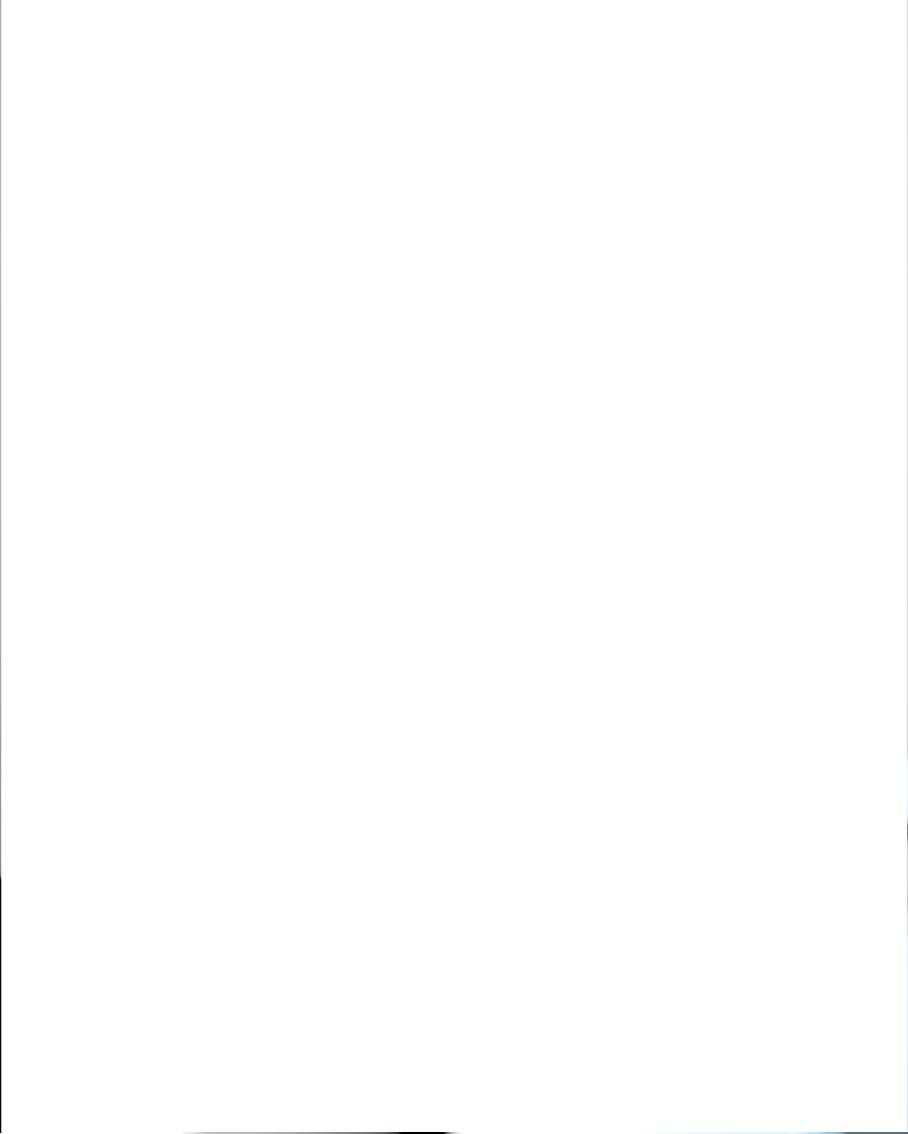



ICON rappresenta un ripensamento globale del concept concesso alla dimensione dell'ufficio, un ritratto innovativo delle direzioni che questo intrigante settore sta intraprendendo.

ICON represents a global reflection on the office dimension, an innovative portrait of the direction this intriguing industry is taking.

ICON représente un revirement global du concept attribué à la dimension du milieu de travail, un portrait innovant des directions que ce fascinant secteur est en train d'amorcer.









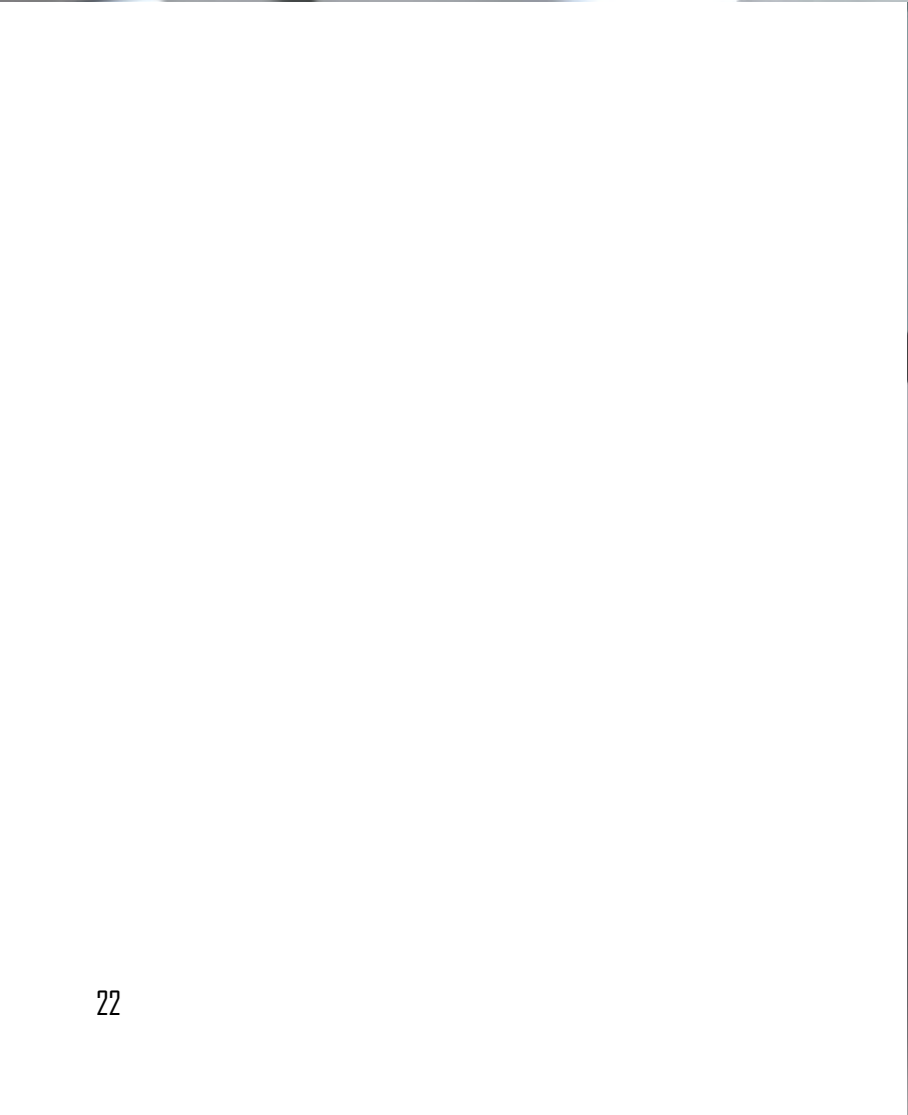









"Ogni uomo è felice quando vive nel suo mondo nel mondo. Dare vita a luoghi confortevoli, accoglienti e dedicati al benessere è il concept che anima la mia filosofia progettuale. Ripensare le aree business e gli arredi che le compongono, in chiave innovativa ed aperta, è indispensabile al fine di soddisfare i desideri ed i bisogni dell'uomo contemporaneo che dedica sempre più energie al lavoro e trascorre una grande parte del suo tempo in ufficio. ICON nasce dal desiderio di essere indispensabile reazione alla cangiante e dinamica contemporaneità."  
Simone Micheli

"We are all happy in our own little world. Giving life to comfortable, welcoming, wellbeing-centric spaces is the concept behind my design philosophy. Reworking business spaces and the furnishings within them, in an innovative and open way, is a must if we are to fulfil the desires and needs of those who, today, are devoting more and more energy to their work and spending so much of their time in the office. ICON offers a very necessary reaction to an ever-changing and dynamic contemporaneity"

"Tous les hommes sont heureux dès lors qu'ils évoluent dans l'univers de leur univers. Donner vie à des lieux confortables, accueillants et dédiés au bien-être est le concept qui anime ma philosophie conceptuelle. Reconsidérer les lieux de travail et le mobilier qui les compose, dans un esprit d'innovation et d'ouverture, est indispensable pour satisfaire les désirs et les besoins de l'homme moderne qui consacre de plus en plus d'énergies à ses activités professionnelles et passe la majorité de son temps au bureau. ICON naît du désir d'être l'indispensable réaction à une modernité aussi versatile que dynamique"

# #SIMONEMICHELI



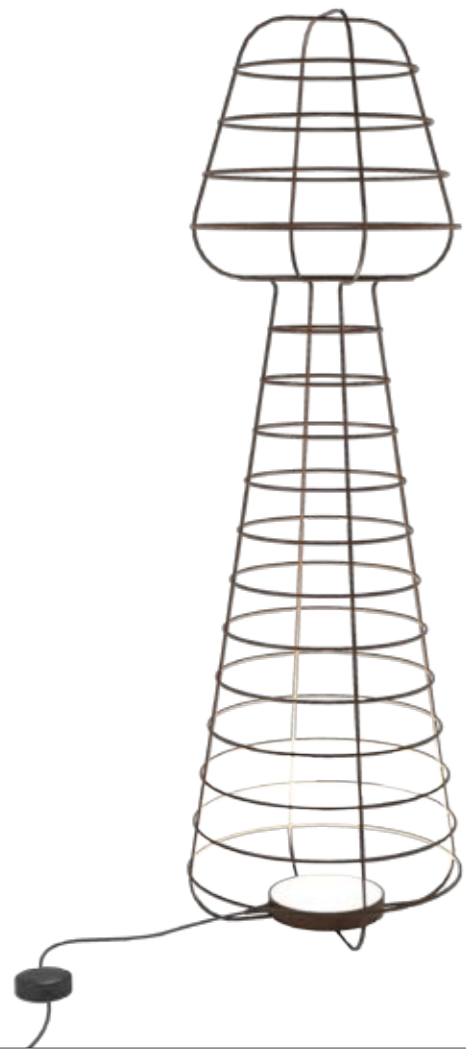

LAMPADA COLOMBINA  
in tondino pieno forgiato a mano  
con luce a LED  
Diametro cm 58  
Altezza cm 180

LAMP in solid iron rod  
forged by hand

LUMIERE en barre de fer  
massif forge à la main



PORTAVASO MOKA  
in tondino pieno  
forgiato a mano  
Diametro cm 60  
Altezza cm 142

PLANTER in solid iron  
rod forged by hand

POT DE FLEURS en barre  
de fer massif forge  
à la main

TAVOLINO CLESSIDRA  
in tondino pieno forgiato a mano  
con ripiano in legno laccato  
Diametro cm 73  
Altezza cm 45

SMALL TABLE in solid iron rod  
forged by hand with wooden shelf

PETITE TABLE en barre de fer  
massif forge à la main  
avec plan en bois



POUF CLESSIDRA  
in tondino pieno forgiato a mano  
con seduta imbottita  
Diametro cm 73  
Altezza cm 50

POUF in solid iron rod  
forged by hand with padded seat

POUF en barre de fer  
massif forge à la main  
avec siège rembourrée



SCRIVANIE H 75

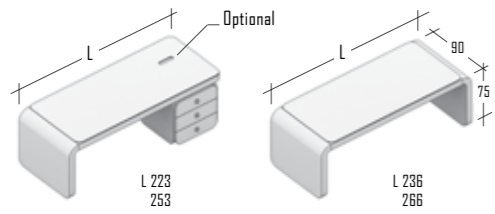

CASSETTIERA

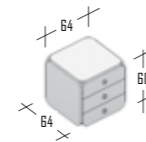

TAVOLI RIUNIONEH 75

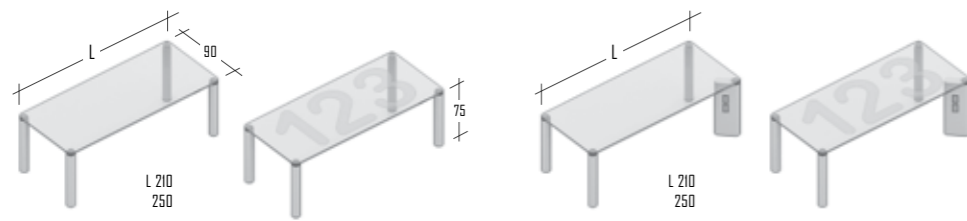

MOBILI ALTI P 52

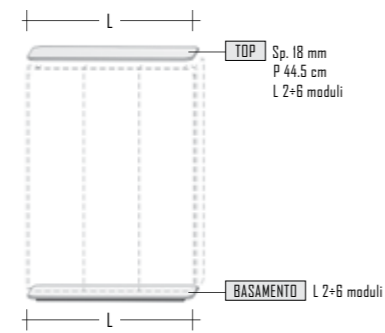
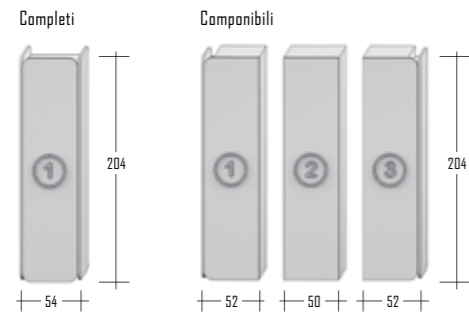

MOBILI BASSI

