

FS
FUNNY
FS
plus

Un progetto versatile e raffinato che prende origine da un'ispirazione minimal-chic e che ha dato vita a un design geometrico e confortevole. Lavorazioni eccellenti e utilizzo di melaminici esclusivi, lo rendono adatto all'ufficio sia per l'operatività singola, sia per la riunione e il contenimento. L'estensione compositiva illimitata a qualsiasi dimensione, forma, accostamento cromatico e finitura, si affina per mezzo di quattro tipologie di struttura: Fianco Legno, Gamba K, Gamba Anello e Gamba U.

A flexible and sophisticated project originated from a minimal-chic inspiration has given rise to comfortable, geometric design. Excellent processing and use of exclusive melamine materials make this perfect for both individual offices and for meeting areas and storage. The limitless possibilities of extending to any shape and size with infinite colour and finish combinations, are enhanced by the four structure types: Wooden Sides, K Leg, Ring Leg and U Leg.

Un projet polyvalent et raffiné qui prend sa source dans une inspiration minimaliste chic et qui a donné vie à un design géométrique et confortable. Les réalisations d'excellente qualité et l'utilisation de mélaminés exclusifs font de lui une solution adaptée au bureau, que ce soit pour le travail individuel ou pour les réunions et le rangement. Les possibilités de composition illimitées, pouvant revêtir n'importe quelle dimension, forme, association chromatique et finition, sont affinées grâce à quatre types de structure : Côté bois, Piètement à K, Piètement en forme d'anneau et Piètement à U.

Indice | Index | Index



Fianco Legno

pag. 4

Wooden Side

Côté Bois



Gamba K

pag. 36

K Leg

Piètement à K

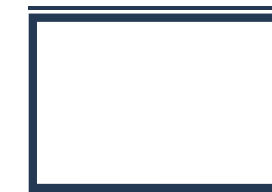

Gamba Anello

pag. 56

Ring Leg

Piètement en forme d'anneau



Gamba U

pag. 74

U Leg

Piètement à U

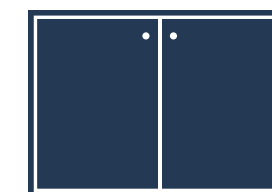

Archiviazione

pag. 98

Storage

Rangement

Gamba K

K Leg

Piètement à K

L'inclinazione della Gamba K è ideale per un ufficio sofisticato e all'avanguardia. Il contrasto tra il raffinato piano di lavoro in melaminico e la solida struttura metallica, è il punto di forza del design minimal-chic ricercato da Funny Plus. Estetica sinuosa, accattivante e accogliente.

The sloping style of the K Leg is ideal for a sophisticated, highly contemporary office. The contrast between the melamine worktop and the solid metal structure, is the leading light of the refined, minimal-chic design of Funny Plus. A warm, captivating and sinuous visual style.

L'inclinaison du piètement à K est idéale pour un bureau sophistiqué et d'avant-garde. Le contraste entre le plan de travail raffiné en mélaminé et la solide structure métallique est le point fort du design minimaliste chic recherché par Funny Plus. Une esthétique sinueuse, séduisante et accueillante.





Sfruttando la vasta gamma di combinazioni cromatiche e materiche, la Gamba K completa l'ambiente direzionale donando rigorosità e dinamismo.

Taking advantage of the wide range of colours and material combinations, the K Leg adds the final touch to an executive environment providing rigour and dynamism.

Exploitant la vaste gamme de combinaisons de couleurs et de matières, le pièment à K complète l'espace de direction en lui donnant rigueur et dynamisme.





I componenti di archiviazione sono il frutto di una studiata economia di spazio, offrendo alla struttura un supporto e un carattere unici.

The storage components are the result of well-researched space economy, providing the structure with unique support and character.

Les composants d'archivage sont le fruit d'une étude poussée du concept de gain de place, qui offre à la structure un support et un caractère uniques.





Il tavolo riunione modulare risponde alle diverse esigenze di spazio e accoglienza, grazie alla regolazione della sua estensione.

The modular meeting table responds to various spacial and comfort needs due to its modular length.

La table de réunion modulaire répond aux diverses exigences d'espace et d'accueil, grâce à la possibilité de régler son extension.



Ispirazione tratta dalla contemporaneità per dare una nuova prospettiva all'ambiente di lavoro, confortevole e di tendenza, con richiami all'arredo casa.

An inspiration with a contemporary flavour to give a new perspective to a working environment that is comfortable and trendy, with touches of a home setting.

Une inspiration tirée du contemporain pour donner une nouvelle perspective à l'espace de travail, confortable et tendance, avec un style qui rappelle l'ameublement de la maison.



Possibilità di creare uno spazio meeting più riservato sfruttando il tavolo riunione Gamba K con piano circolare.

Possibilities to configure a more private meeting space by exploiting the K Leg meeting table with a round top.

Possibilité de créer un espace réunion plus confidentiel en exploitant la table de réunion à piètement à K et plateau circulaire.

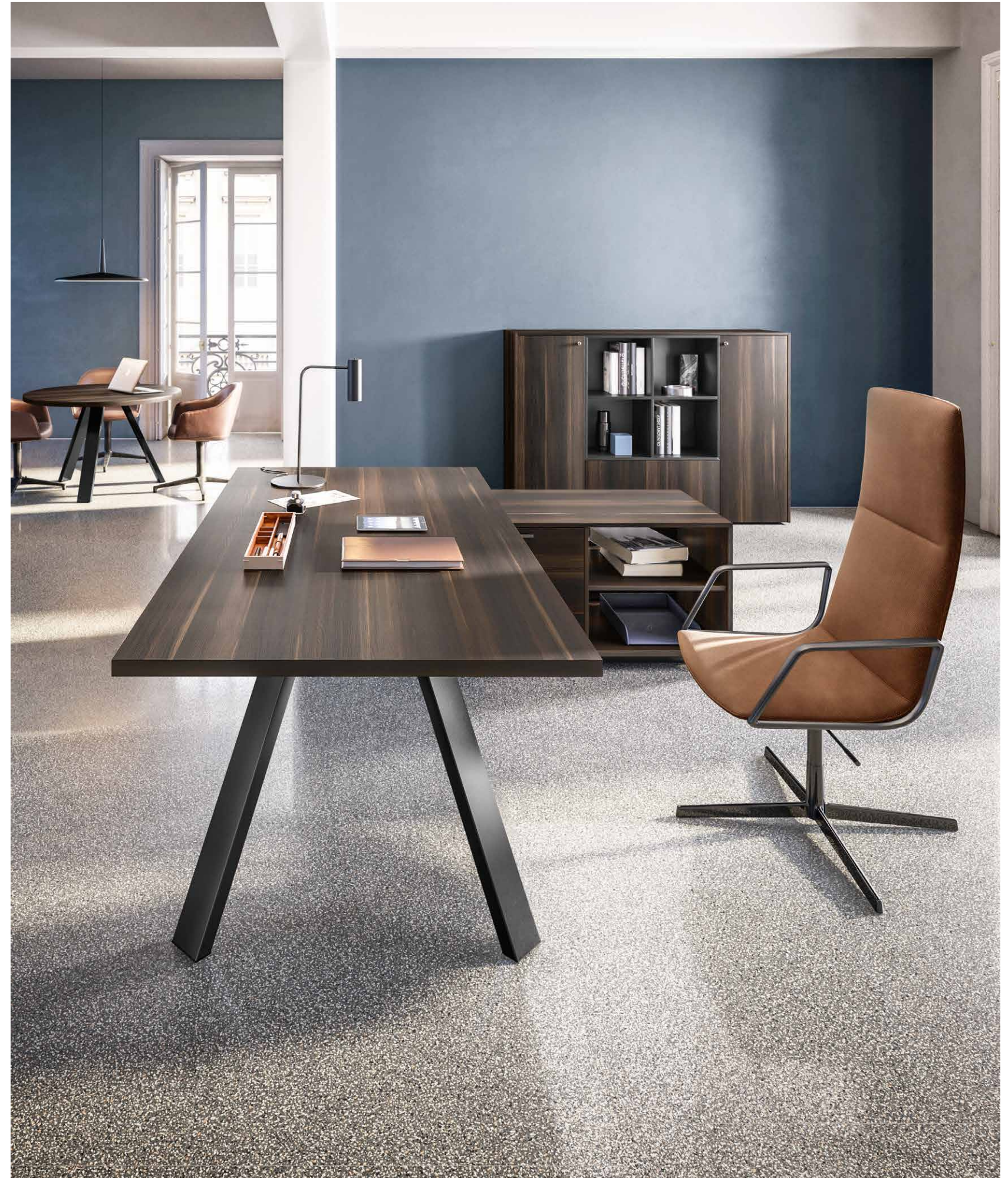





Dal tavolo singolo al tavolo riunione composto, un piano sempre funzionale per gli ospiti delle sale meeting.

Either as a single table or as a modular meeting table, it always provides a functional worktop for meeting room guests.

De la table individuelle à la table de réunion composée, un plan de travail toujours fonctionnel pour les invités des salles de réunions.



La superficie sagomata dei piani rende i tavoli riunione ergonomici e crea un originale contrasto di linee con la struttura.

The shaped tops make these meeting tables ergonomic and create an original contrast of lines with the structure.

La surface profilée des plateaux rend les tables de réunion ergonomiques et crée un original contraste de lignes avec la structure.





Melaminico | Melamine | Mélamine

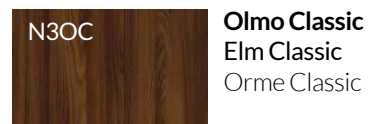
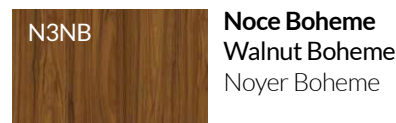
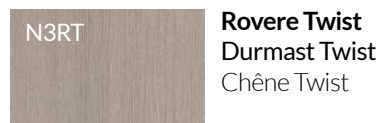

Metallo | Metal | Métal

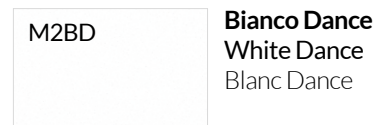
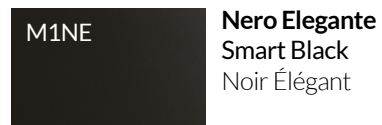

Scrivanie | Desks | Bureaux

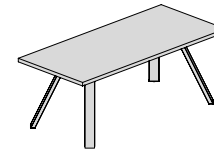

L 200 P 90
L 180 P 90

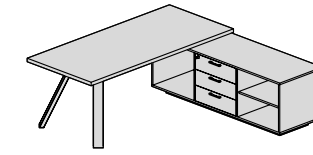

L 223 P 189
L 203 P 135

Tavoli Riunioni | Meeting Tables | Tables de Réunion

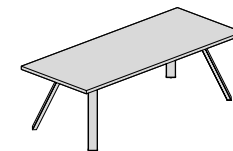

L 240 P 100
L 210 P 100
L 118 P 120

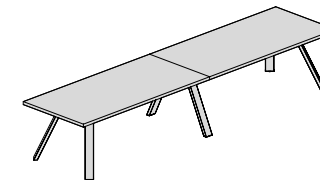

L 630 P 100
L 420 P 100

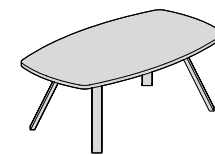

L 210 P 120

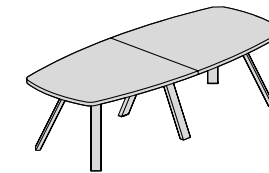

L 516 P 120
L 398 P 120
L 280 P 120

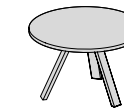

ø120

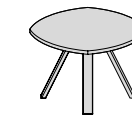

L 108 P 108

Gamba K di Funny Plus dispone di un'ampia serie di melaminici esclusivi per i piani, che abbinati alle finiture della gamba permettono molteplici combinazioni cromatiche.

The K Leg of Funny Plus features a wide variety of exclusive melamine tops, which combined with the leg finishes can create a whole host of colourful combinations.

La gamme de modèles à piètement à K de Funny Plus comporte une vaste série de mélaminés exclusifs pour les plateaux qui, associés aux finitions du pied, permettent de multiples combinaisons chromatiques.

Gamba anello

Ring Leg

Piètement en forme d'anneau

La leggerezza e la raffinatezza dei piani entrano in armonia con l'eleganza geometrica della struttura metallica ad anello. Il disegno squadrato e sottile segue linee pure e rigorose che trasmettono razionalità e precisione.

The lightness and sophistication of the tops are in total harmony with the geometric elegance of the ring metal structure. The square and slim design follows clean, rigorous lines that transmit rationality and precision.

La légèreté et le raffinement des plateaux sont en parfaite harmonie avec l'élégance géométrique de la structure métallique en forme d'anneau. La forme carrée et fine suit des lignes pures et rigoureuses qui transmettent une sensation de rationnel et de précision.

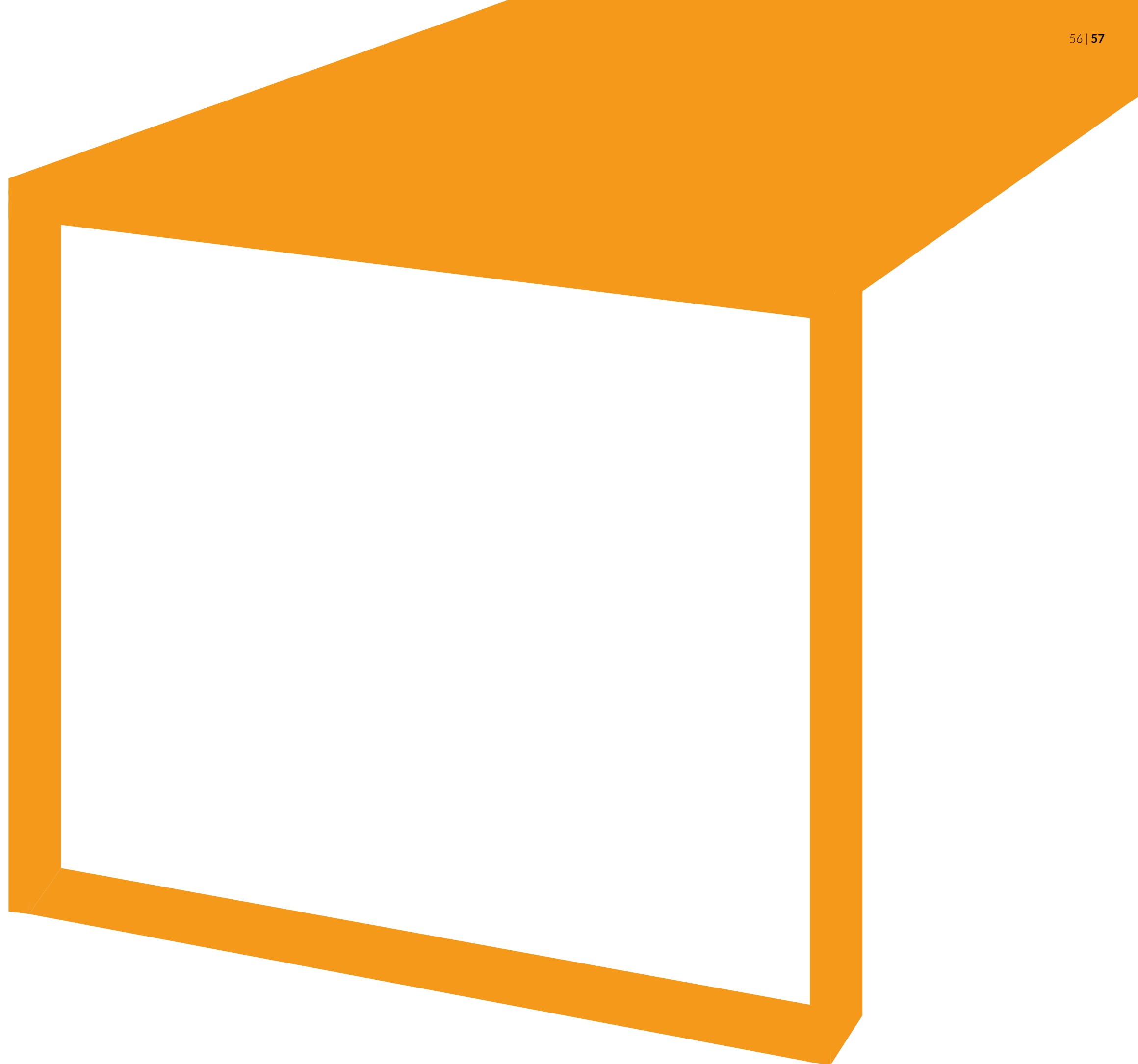



Totalmente anticonvenzionale.
La forma ad anello è nata da un gioco di pieni e di vuoti, per dare un'ottica accattivante all'ufficio.

Totally unconventional.
The ring shape derives from a playful use of solids and voids, to provide the office with a captivating perspective.

Totalement non conventionnel.
La forme d'anneau est née d'un jeu de pleins et de vides, pour donner une optique attrayante au bureau.







Il tavolo con gamba singola sfrutta il sostegno del mobile di contenimento e dà vita ad una configurazione composita funzionale.

The desk with just a single leg exploits the support provided by the service unit and gives rise to a functional composite formation.

La table à un seul piètement utilise le meuble de rangement comme support et donne vie à une configuration composite fonctionnelle.



La grande componibilità della linea direzionale Gamba Anello di Funny Plus permette l'ottimizzazione dello spazio e dell'archiviazione d'ufficio sviluppando isole di lavoro elaborate.

The great modularity in the executive line of the Ring Leg of Funny Plus allows office space and storage to be optimised by developing sophisticated workplaces.

Les nombreuses possibilités de composition de la ligne de direction avec Piètement en forme d'anneau de Funny Plus permettent d'optimiser l'espace et l'archivage dans le bureau en développant des îlots de travail élaborés.







Il tavolo riunione, con struttura rientrante e piano in vetro, crea aree meeting confortevoli ed impeccabili.





The meeting table with a recessed structure and glass top, creates comfortable and impeccable meeting areas.

La table de réunion, avec structure rentrante et plateau en verre, crée des espaces de meeting confortables et impeccables.





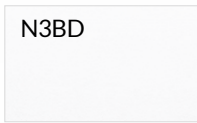
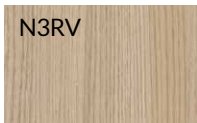

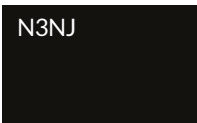
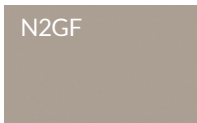

Melaminico | Melamine | Mélamine

 N3RT Rovere Twist Durmast Twist Chêne Twist	 N3NB Noce Boheme Walnut Boheme Noyer Boheme	 N3EU Eucalipto Eucalyptus	 N3BD Bianco Dance White Dance Blanc Dance
 N3RV Rovere Oak Chêne	 N3OC Olmo Classic Elm Classic Orme Classic	 N3NJ Nero Jazz Black Jazz Noir Jazz	 N2GF Grigio Fango Mud Grey Gris Boue

Metallo | Metal | Métal

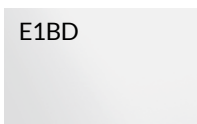
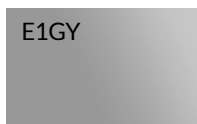
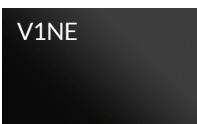
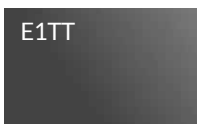
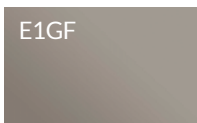
 M1NE Nero Elegante Smart Black Noir Éléant	 M2BD Bianco Dance White Dance Blanc Dance	 M2AG Alluminio Goffrato Embossed Metal Alu Aluminium Gaufré
--	--	---

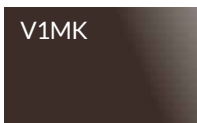
Vetro | Glass | Verre

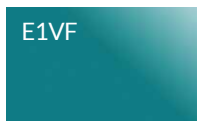
 E1BD Bianco Dance White Dance Blanc Dance	 E1GY Grigio Yoga Yoga Grey Gris Yoga	 V1NE Nero Elegante Smart Black Noir Éléant	 E1TT Titanio Titanium Titane
 E1GF Grigio Fango Mud Grey Gris Boue	 V1BV Blu Vivo Sparkling Blue Blue Brillant	 E1MS Marsala Marsala Marsala	 V1MK Moka Moka Moka
 E1DE Denim Denim Denim	 E1VF Verde Foresta Forest Green Forêt Verte		

Scrivanie | Desks | Bureaux

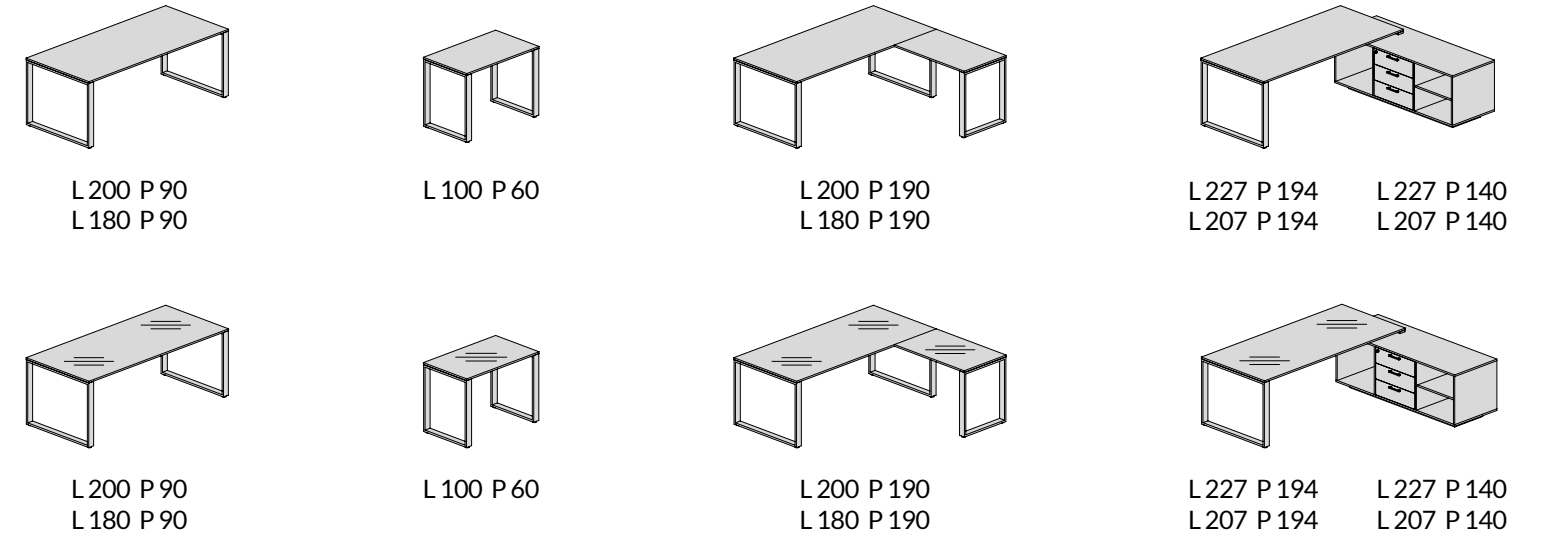

Tavoli Riunioni | Meeting Tables | Tables de Réunion

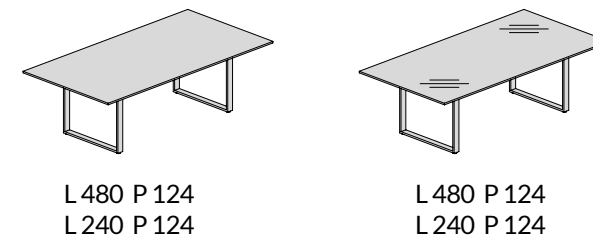

Utilizzando le stesse colorazioni per superfici in melaminico, metallo e vetro si conferisce continuità ai vari spazi lavorativi.

By using the same colours for melamine, metal and glass surfaces, one achieves a seamlessness among the various working spaces.

En utilisant les mêmes couleurs pour les surfaces en mélaminé, métal et verre, on confère une certaine continuité aux différents espaces de travail.





Le cromie selezionate per i melaminici si legano tra loro armoniosamente e permettono di configurare sistemi di contenimento esteticamente accattivanti, con la possibilità di inserire un'ulteriore base che li completa.

The selected colours for the melamine surfaces blend harmoniously and allow to arrange aesthetically appealing storage systems, with the possibility of including an additional base that provides the final touch.

Les variantes chromatiques sélectionnées pour les mélaminés se lient harmonieusement entre elles et permettent de configurer des systèmes de rangement attrayants du point de vue esthétique, avec la possibilité d'ajouter un socle supplémentaire pour les compléter.



La purezza delle linee che caratterizza la Gamba U viene enfatizzata dalla sottile superficie di lavoro in vetro.

The purity of the lines that characterises the U Leg is enhanced by the slim glass top.

La pureté des lignes qui caractérise le piètement à U est accentuée par la mince surface de travail en verre.

L'ufficio direzionale acquista luminosità e carattere grazie alla Gamba U e al piano in vetro, disponibile in un'ampia scelta cromatica.

The executive office acquires brightness and character thanks to the U leg and the glass top, available in a wide choice of colours.

Le bureau de la direction gagne en luminosité et en caractère grâce au piètement à U et au plateau en verre, disponible dans une large gamme de choix chromatiques.



**Il colore nero per il piano quadrato
in melaminico e per la struttura in metallo
dà risalto agli elementi d'arredo dai colori vivaci.**

The black melamine square top and black
metal structure emphasise the furniture
elements in bright colours.

La couleur noire du plateau carré en mélaminé
et de la structure en métal met en valeur les
éléments d'ameublement aux couleurs vives.





Sempre al passo con le diverse esigenze di utilizzo, optando per un tavolo con sistema di elettrificazione centrale e top access.

Always in tune with the various working requirements, selecting a table with integrated vertical cable management and top access.

Une solution toujours en phase avec les diverses exigences d'utilisation, grâce au choix d'une table avec système d'électrification central accessible par le haut.





Scrivanie | Desks | Bureaux

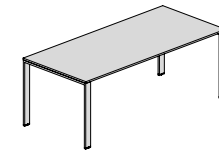

L 200 P 90
L 180 P 90

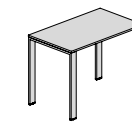

L 100 P 60

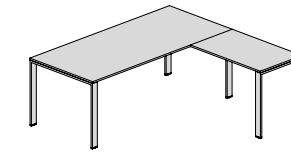

L 200 P 190
L 180 P 190

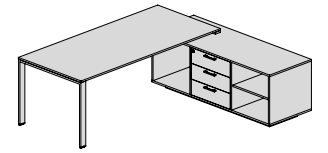

L 227 P 194 L 227 P 140
L 207 P 194 L 207 P 140

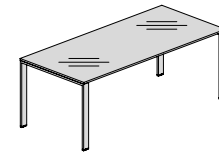

L 200 P 90
L 180 P 90

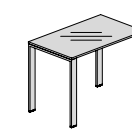

L 100 P 60

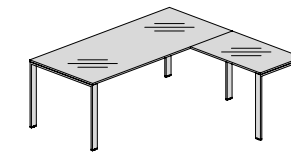

L 200 P 190
L 180 P 190

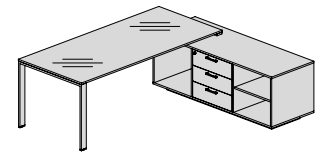

L 227 P 194 L 227 P 140
L 207 P 194 L 207 P 140

Melaminico | Melamine | Mélangine

N3RT	Rovere Twist Durmast Twist Chêne Twist	N3NB	Noce Boheme Walnut Boheme Noyer Boheme	N3EU	Eucalipto Eucalyptus Eucalyptus	N3BD	Bianco Dance White Dance Blanc Dance
N3RV	Rovere Oak Chêne	N3OC	Olmo Classic Elm Classic Orme Classic	N3NJ	Nero Jazz Black Jazz Noir Jazz	N2GF	Grigio Fango Mud Grey Gris Boue

Metallo | Metal | Métal

M1NE	Nero Elegante Smart Black Noir Éléphant	M2BD	Bianco Dance White Dance Blanc Dance	M2AG	Alluminio Goffrato Embossed Metal Alu Aluminium Gaufré
------	--	------	---	------	---

Vetro | Glass | Verre

E1BD	Bianco Dance White Dance Blanc Dance	E1GY	Grigio Yoga Yoga Grey Gris Yoga	V1NE	Nero Elegante Smart Black Noir Éléphant	E1TT	Titanio Titanium Titane
E1GF	Grigio Fango Mud Grey Gris Boue	V1BV	Blu Vivo Sparkling Blue Blue Brillant	E1MS	Marsala Marsala Marsala	V1MK	Moka Moka Moka
E1DE	Denim Denim Denim	E1VF	Verde Foresta Forest Green Forêt verte				

Tavoli Riunioni | Meeting Tables | Tables de Réunion

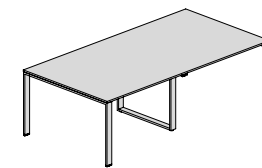

L 240 P 124

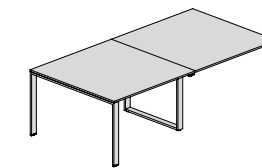

L 360 P 124
L 240 P 124
L 120 P 124

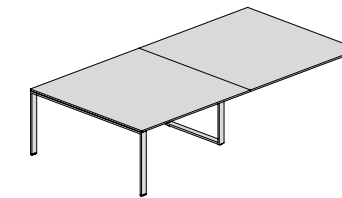

L 480 P 164
L 320 P 164
L 160 P 164

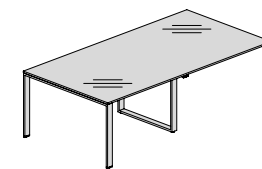

L 240 P 124

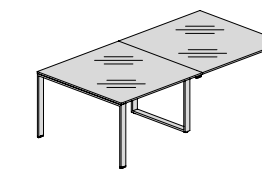

L 360 P 124
L 240 P 124
L 120 P 124

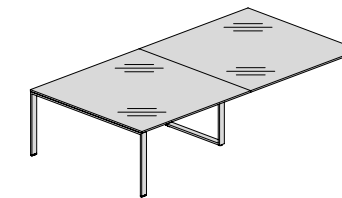

L 480 P 164
L 320 P 164
L 160 P 164

Ampia gamma di finiture in melaminico e in vetro in abbinamento alla struttura della Gamba U, sia singola, in modalità d'appoggio, sia freestanding.

A wide range of finishes in melamine and glass in combination with the U Leg, either as a single unit, in supported mode, or free-standing.

Une large gamme de finitions en mélaminé et verre à associer à la structure du piètement à U, que l'on peut utiliser seul, posé sur un autre élément ou dans une version mobile.



Elementi aperti, pannellature e capienti moduli chiusi sono solo alcuni dei componenti che completano l'arredamento in modo pratico e accogliente.

Open elements, panelling and spacious, enclosed modules are just some of the components that add the practical and welcoming finishing touches to this decor.

Éléments ouverts, panneaux et grands modules fermés ne sont que quelques-uns des composants qui complètent l'aménagement de manière pratique et accueillante.





L'eleganza dello spazio meeting è trasmessa dagli accordi di elementi aperti e moduli chiusi, tavoli sagomati e modulari, basi e consolle.

The elegance of the meeting area is conveyed by the harmonious combination of open elements and closed modules, shaped and modular tables, bases and consoles.

L'élégance de l'espace de réunion est transmise par le mariage d'éléments ouverts et de modules fermés, de tables profilées et modulaires, d'éléments bas et de consoles.





Giochi di volumi, linee e livelli: il Fianco Legno esprime l'originalità e il forte impatto estetico degli spazi polifunzionali.

Playful volumes, lines and levels: the Wooden Sides express the originality and aesthetically-pleasing impact of the multi-purpose areas.

Jeux de volumes, lignes et niveaux : le côté bois exprime l'originalité et le fort impact esthétique des espaces multifonctions.



Grande proprietà di adattamento, con possibilità di scelta tra mobili di servizio portanti o freestanding, a seconda delle necessità.

Enormous capacity for adaptation, with a choice of supporting or free-standing service units, according to needs.

Une grande capacité d'adaptation, avec la possibilité de choisir entre meubles de services porteurs ou indépendants, selon les besoins.

Archiviazione

Storage

Rangement

Una linea di mobili d'archiviazione componibili e dall'estetica minimal ed ergonomica, per sfruttare al meglio gli spazi. La sovrapposizione di vani aperti ad elementi chiusi è la chiave per creare un ufficio funzionale e di tendenza, il cui tocco finale sarà dato dalle combinazioni cromatiche.

A line of modular storage units with a minimalist visual appeal and highly ergonomic, designed to make the most of available space.

The combination of open sections and closed elements is the key to creating a functional and trendy office, whose final touch is provided by carefully blending the colours.

Une ligne de meubles d'archivage modulables et à l'esthétique minimaliste et ergonomique, pour exploiter au mieux les espaces.

La superposition de compartiments ouverts et d'éléments fermés est la clé pour créer un bureau fonctionnel et de tendance, auquel la touche finale sera donnée par les combinaisons chromatiques.

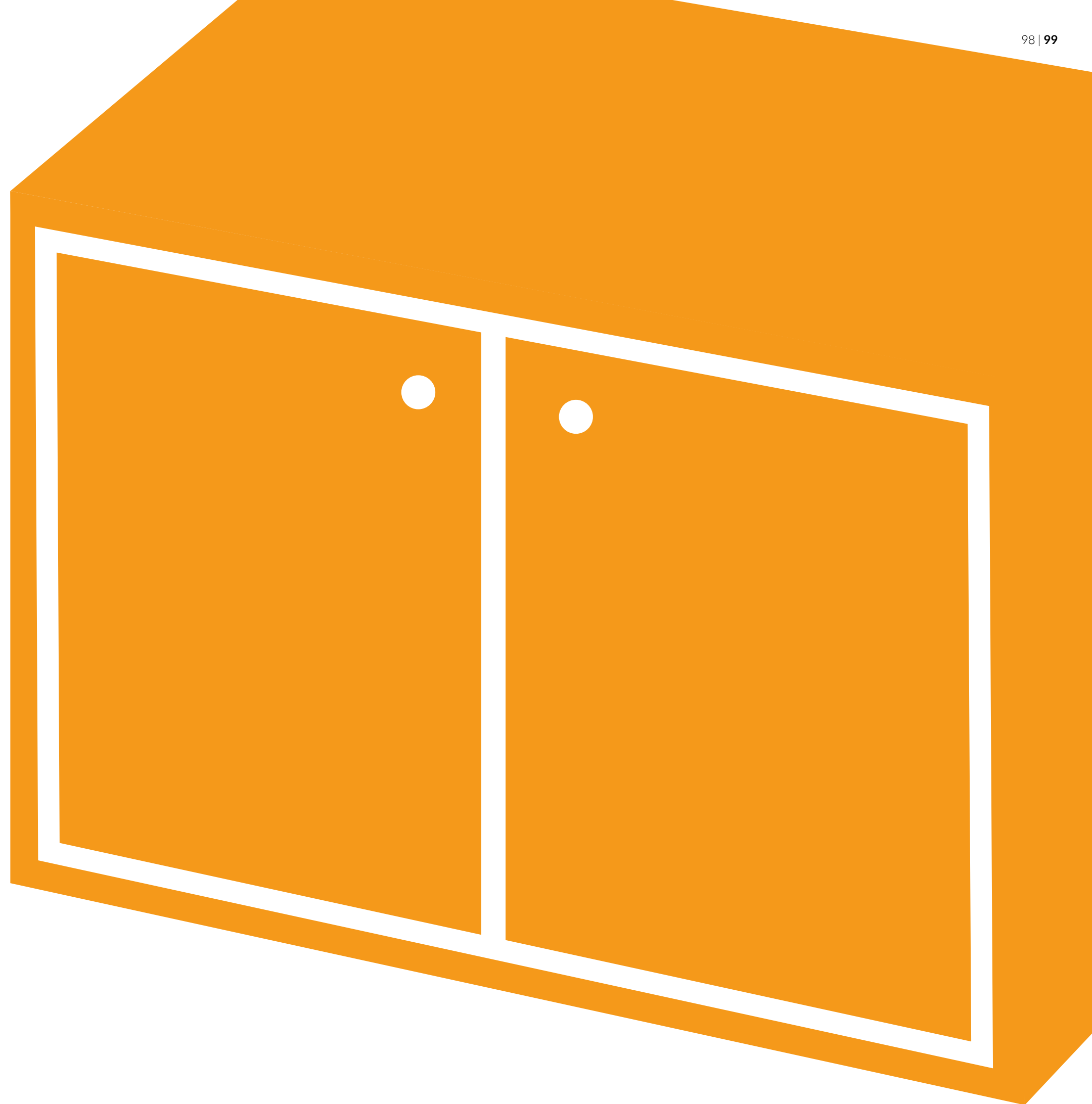

Mobili di servizio e cassettiere minimal-chic, ideali per affiancare le scrivanie direzionali. Soluzioni in appoggio o freestanding, in base alle necessità, disponibili in differenti dimensioni.

Minimal-chic service units and pedestals, the ideal companions for executive desks. Joined or free-standing solutions, according to necessity, available in various sizes.

Meubles de service et caissons minimalistes chics, parfaits pour accompagner les bureaux de direction. Des solutions à poser ou mobiles, selon les besoins, disponibles dans différentes dimensions.



Mobili di servizio - melaminico sp.18 | Service units - MFC th. 18mm | Meubles de service - mélamine ép.18

N3BD	Bianco Dance White Dance Blanc Dance	N3RT	Rovere Twist Durmast Twist Chêne Twist	N3NB	Noce Boheme Walnut Boheme Noyer Boheme	N3EU	Eucalipto Eucalyptus Eucalyptus
N2GF	Grigio Fango Mud Grey Gris Boue	N3RV	Rovere Oak Oak Chêne	N3OC	Olmo Classic Elm Classic Orme Classic	N3NJ	Nero Jazz Black Jazz Noir Jazz

Schienale in metallo | Metal back panel | Dos en métal

M2BD	Bianco Dance White Dance Blanc Dance	M1NE	Nero Elegante Smart Black Noir Éléphant
------	---	------	--

Cassettiere - melaminico sp. 18 | Pedestals - MFC th. 18mm | Caissons - mélamine ép.18

N3BD	Bianco Dance White Dance Blanc Dance	N3RT	Rovere Twist Durmast Twist Chêne Twist	N3NB	Noce Boheme Walnut Boheme Noyer Boheme	N3EU	Eucalipto Eucalyptus Eucalyptus
N2GF	Grigio Fango Mud Grey Gris Mud	N3RV	Rovere Oak Oak Chêne	N3OC	Olmo Classic Elm Classic Orme Classic	N3NJ	Nero Jazz Black Jazz Noir Jazz

Cassettiere - metallo | Pedestals - metal | Caissons - métal

M2BD	Bianco Dance White Dance Blanc Dance	M1NE	Nero Elegante Smart Black Noir Éléphant	M2AG	Alluminio Goffrato Embossed Metal Alu Aluminium Gauffré
------	---	------	--	------	--

Mobili di servizio direzionali | Executive service units | Meubles de service de direction

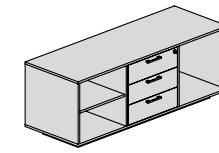

L 169 P 60 H 62

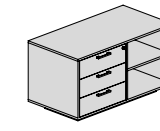

L 115 P 60 H 62

Mobili di servizio componibili | Modular service units | Meubles de service modulables

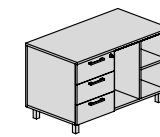

L 102 P 57 H 62

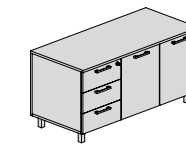

L 125 P 57 H 62

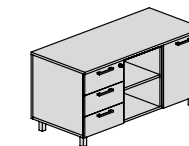

L 125 P 57 H 62

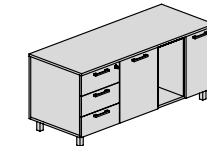

L 143 P 57 H 62

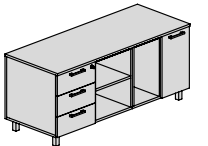

L 143 P 57 H 62

Cassettiere in melaminico | MFC pedestals | Caissons en mélaminé



L 41,5 P 55 H 60

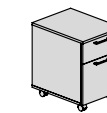

L 41,5 P 55 H 60

Cassettiere in metallo | Metal pedestals | Caissons en métal

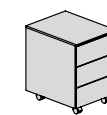

L 42,5 P 53 H 58

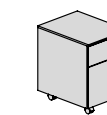

L 42,5 P 53 H 58

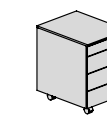

L 42,5 P 53 H 58

Pensili e mensole di vari volumi creano composizioni in sospensione dal forte impatto visivo. Grande praticità delle librerie, estendibili all'infinito, a cui è possibile integrare ante in melaminico o vetro.

Wall units and shelves of various sizes create suspended compositions with a strong visual impact. Highly practical bookcases that can be extended indefinitely and enhanced with melamine or glass doors.

Les éléments de rangement suspendus et les étagères aux volumes variés créent des compositions en suspension à fort impact visuel. Extensibles à l'infini, avec la possibilité d'y intégrer des portes en mélaminé ou en verre, les bibliothèques sont extrêmement pratiques.

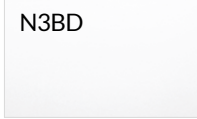
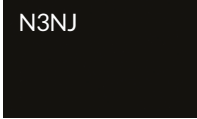
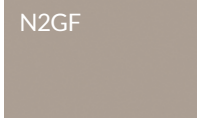

Strutture pensili - melaminico sp.18 | Wall unit structures - MFC th. 18 | Structures éléments de rangement suspendus - mélamine ép.18

 N3BD	Bianco Dance White Dance Blanc Dance	 N3NJ	Nero Jazz Black Jazz Noir Jazz	 N2GF	Grigio Fango Mud Grey Gris Boue
---	---	--	---	---	--

Ante e frontali pensili - melaminico sp.18 | Wall unit doors and fronts - MFC th. 18 | Portes et façades pour éléments de rangement suspendus - mélamine ép.18

 N3BD	Bianco Dance White Dance Blanc Dance	 N3RT	Rovere Twist Durmast Twist Chêne Twist	 N3NB	Noce Boheme Walnut Boheme Noyer Boheme	 N3EU	Eucalipto Eucalyptus Eucalyptus
 N2GF	Grigio Fango Mud Grey Gris Mud	 N3RV	Rovere Oak Chêne	 N3OC	Olmo Classic Elm Classic Orme Classic	 N3NJ	Nero Jazz Black Jazz Noir Jazz

Strutture librerie - melaminico sp.25 | Bookcase structures - MFC th. 25 | Structures pour bibliothèques - mélamine ép.25

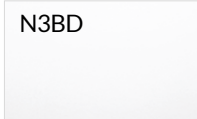
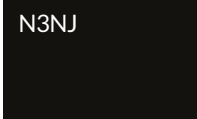
 N3BD	Bianco Dance White Dance Blanc Dance	 N3NJ	Nero Jazz Black Jazz Noir Jazz
--	---	---	---





Ante e frontali librerie - melaminico sp.18 | Bookcase doors and fronts - MFC th. 18 | Portes et façades pour bibliothèques - mélamine ép.18

 N3BD	Bianco Dance White Dance Blanc Dance	 N3RT	Rovere Twist Durmast Twist Chêne Twist	 N3NB	Noce Boheme Walnut Boheme Noyer Boheme	 N3EU	Eucalipto Eucalyptus Eucalyptus
 N2GF	Grigio Fango Mud Grey Gris Mud	 N3RV	Rovere Oak Chêne	 N3OC	Olmo Classic Elm Classic Orme Classic	 N3NJ	Nero Jazz Black Jazz Noir Jazz



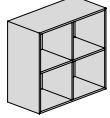
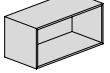

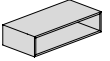
Ante e frontali librerie - vetro sp.4 | Bookcase doors and fronts - glass th. 4 | Portes et façades pour bibliothèques - verre ép.4

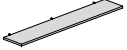
 V2VS	Vetro Satinato Satinated Glass Verre Satiné	 V1GE	Grigio Europeo European Grey Gris Européen
---	--	--	---

Pensili a giorno e mensole | Open wall units and shelves | Éléments de rangement suspendus ouverts et étagères

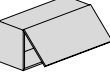
 L 90 P 43 H 83,2 L 90 P 33 H 83,2	 L 90 P 43 H 41,6 L 90 P 33 H 41,6	 L 45 P 43 H 41,6 L 45 P 33 H 41,6	 L 90 P 43 H 20,8 L 90 P 33 H 20,8	 L 45 P 43 H 20,8 L 45 P 33 H 20,8	 L 180 P 32 sp. 2,5 L 135 P 32 sp. 2,5 L 90 P 32 sp. 2,5
---	---	---	---	---	--

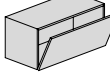
Pensili con ante | Wall units with doors | Éléments de rangement suspendus avec portes

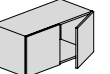
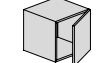
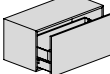
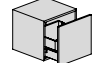
 L 90 P 35 H 41,6	 L 45 P 45 H 41,6 L 45 P 35 H 41,6	 L 90 P 45 H 41,6 L 90 P 35 H 41,6	 L 45 P 45 H 41,6 L 45 P 35 H 41,6
 L 90 P 45 H 41,6 L 90 P 35 H 41,6	 L 45 P 45 H 41,6 L 45 P 35 H 41,6	 L 90 P 45 H 41,6	 L 45 P 45 H 41,6

Libreria a spalla condivisa | Bookcase with shared side panel | Bibliothèque à côté partagé

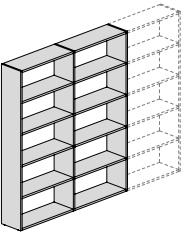
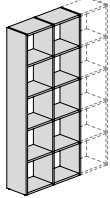
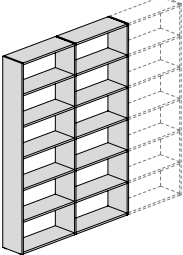
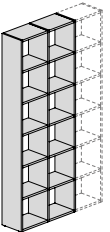
 P 33 H 209	 P 33 H 209	 P 33 H 250	 P 33 H 250
--	--	--	--

Libreria a spalla condivisa con ante in melaminico | Bookcase with shared side panel and melamine doors | Bibliothèque à côté partagé avec portes en mélaminé

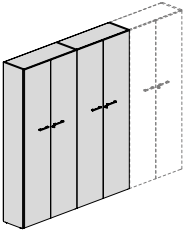
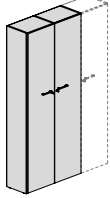
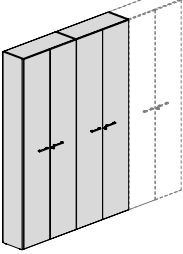
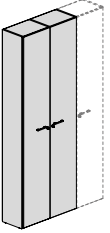
 P 35 H 209	 P 35 H 209	 P 35 H 250	 P 35 H 250
---	---	---	---

Libreria a spalla condivisa con ante in vetro | Bookcase with shared side panel and glass doors | Bibliothèque à côté partagé avec portes en verre

 P 35 H 209	 P 35 H 209
---	---

Nate dall'abbinamento di pensili e contenitori, le madie costituiscono una combinazione ingegnosa: una soluzione dal design attuale per risolvere necessità di archiviazione e stile.

Conceived by matching wall units with storage units, the sideboards are an ingenious combination: a contemporary design solution to solve both storage and style needs.

Nés de l'association d'éléments hauts et de meubles de rangement, les buffets constituent une combinaison ingénieuse : une solution au design actuel pour répondre aux besoins d'archivage et de style.



Strutture pensili per madie - melaminico sp.18 | Wall structures for sideboards - MFC th. 18 | Structures éléments hauts pour buffets - mélamine ép.18

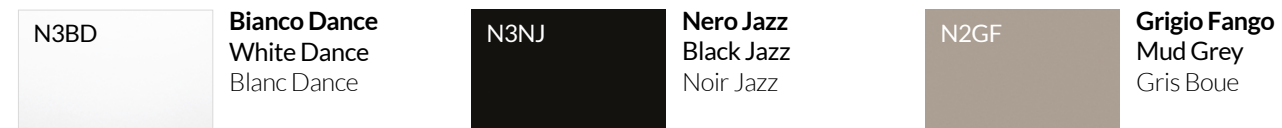

Strutture contenitori per madie - melaminico sp.18 | Storage units for sideboards - MFC th. 18 | Structures meubles de rangement pour buffets - mélamine ép.18



Ante e frontali per madie - melaminico sp.18 | Doors and fronts for sideboards - MFC th. 18 | Portes et façades pour buffets - mélamine ép.18



Ante e frontali per madie - vetro sp.4 | Doors and fronts for sideboards - glass th. 4 | Portes et façades pour buffets - verre ép.4

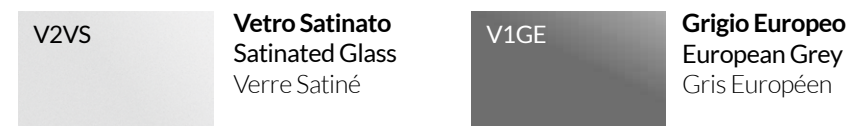

Madie | Sideboards | Buffets

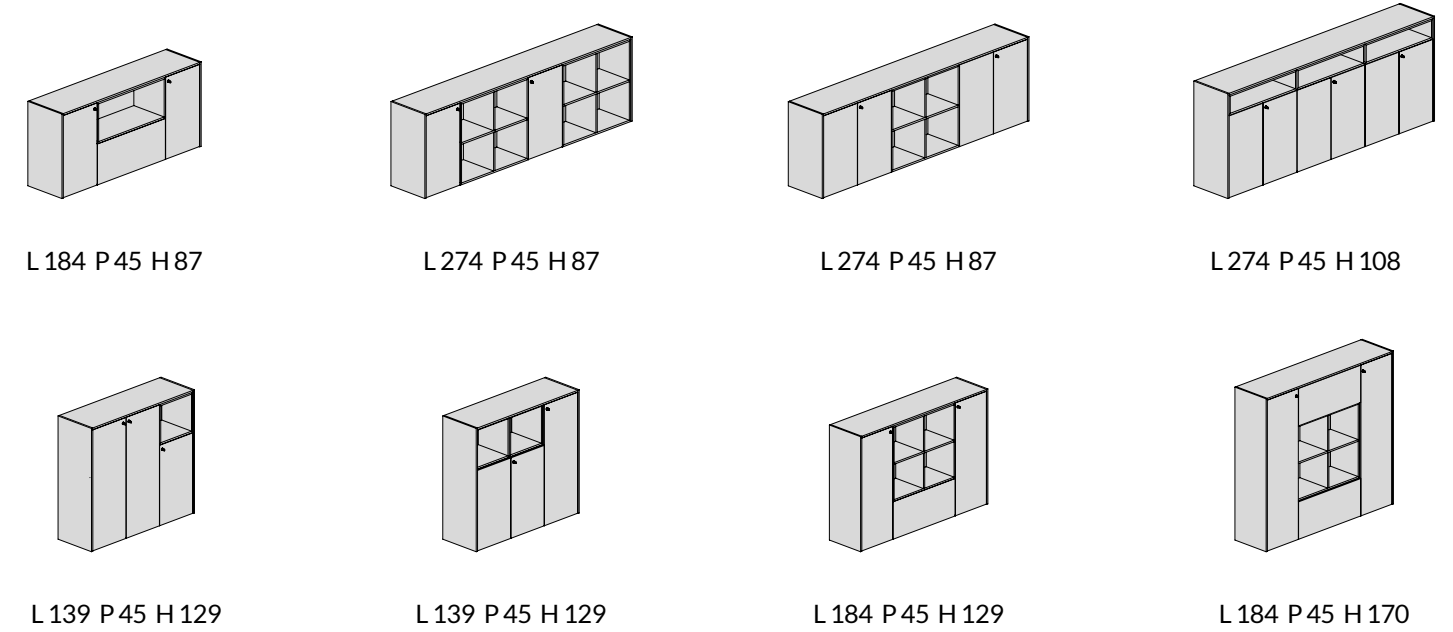

Piena libertà di composizione associando tra loro vari formati, finiture, contenitori chiusi ed elementi a giorno per realizzare un ufficio dinamico e soddisfare qualsiasi esigenza.

The ultimate in compositional freedom: association of various sizes, finishes, closed storage units and open elements to create a dynamic office that meets every need.





Liberté de composition totale en associant divers formats, finitions, meubles de rangement fermés et éléments ouverts pour réaliser un bureau dynamique et répondre à n'importe quelle exigence.



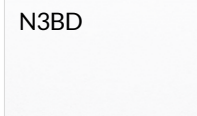

Strutture contenitori - melaminico sp.18 | Storage unit structures - MFC th. 18 | Structures armoires - mélamine ép.18

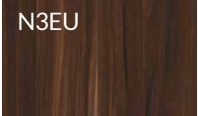
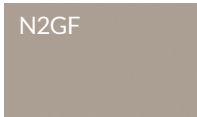
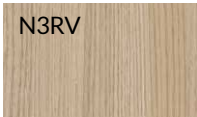
 N3BD Bianco Dance White Dance Blanc Dance	 N2GN Grigio Nuvola Cloud Grey Nuage Gris	 N3NJ Nero Jazz Black Jazz Noir Jazz
--	--	--

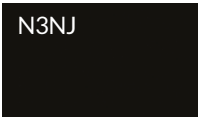
Ante, top e fianchi di finitura - melaminico sp.18 | Doors, finishing top and side panels - MFC th. 18 | Portes, tops et côtés de finition - mélamine ép.18

 N3BD Bianco Dance White Dance Blanc Dance	 N3RT Rovere Twist Durmast Twist Chêne Twist	 N3NB Noce Boheme Walnut Boheme Noyer Boheme	 N3EU Eucalipto Eucalyptus Eucalyptus
 N2GF Grigio Fango Mud Grey Gris Boue	 N3RV Rovere Oak Oak Chêne	 N3OC Olmo Classic Elm Classic Orme Classic	 N3NJ Nero Jazz Black Jazz Noir Jazz

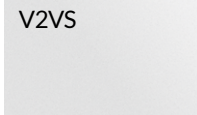

Ante contenitori - vetro sp.4 | Storage unit doors - glass th. 4 | Portes armoires - verre ép.4

 V2VS Vetro Satinato Satinated Glass Verre Satiné	 V1GE Grigio Europeo European Grey Gris Européen
---	---

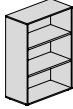
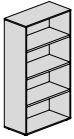
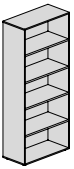

Contentori a giorno | Open storage units | Armoires à jour

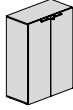
 L 90 P 43 H 85 L 90 P 33 H 85 L 45 P 43 H 85 L 45 P 33 H 85	 L 90 P 43 H 127 L 90 P 33 H 127 L 45 P 43 H 127 L 45 P 33 H 127	 L 90 P 43 H 168 L 45 P 43 H 168	 L 90 P 43 H 210 L 90 P 33 H 210 L 45 P 43 H 210 L 45 P 33 H 210
---	---	---	---

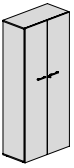
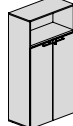
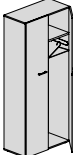
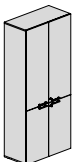
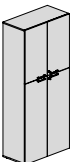
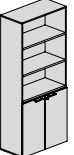

Contentori con ante in melaminico | Storage units with MFC doors | Armoires avec portes en mélamine

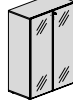
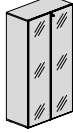
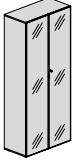
 L 90 P 45 H 85 L 90 P 35 H 85 L 45 P 45 H 85 L 45 P 35 H 85	 L 90 P 45 H 127 L 90 P 35 H 127 L 45 P 45 H 127 L 45 P 35 H 127	 L 90 P 45 H 168 L 45 P 45 H 168	 L 90 P 45 H 210 L 90 P 35 H 210 L 45 P 45 H 210 L 45 P 35 H 210	
 L 90 P 45 H 168 L 45 P 45 H 168	 L 90 P 45 H 210 L 45 P 45 H 210	 L 90 P 45 H 210 L 90 P 35 H 210 L 45 P 45 H 210 L 45 P 35 H 210	 L 90 P 45 H 210 L 90 P 35 H 210 L 45 P 45 H 210 L 45 P 35 H 210	 L 90 P 45 H 210 L 90 P 35 H 210 L 45 P 45 H 210 L 45 P 35 H 210

Contentori con ante in vetro e telaio alluminio | Storage units with aluminium framed glass doors | Armoires avec portes en verre et cadre en aluminium

 L 90 P 45 H 127 L 90 P 35 H 127 L 45 P 45 H 127 L 45 P 35 H 127	 L 90 P 45 H 168 L 45 P 45 H 168	 L 90 P 45 H 210 L 90 P 35 H 210 L 45 P 45 H 210 L 45 P 35 H 210	 L 90 P 45 H 210 L 90 P 35 H 210 L 45 P 45 H 210 L 45 P 35 H 210
---	---	---	---

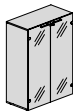
Contentori con ante in vetro fumè | Storage units with smoked glass doors | Armoires avec portes en verre fumé

 L 90 P 45 H 85 L 90 P 35 H 85 L 45 P 45 H 85 L 45 P 35 H 85	 L 90 P 45 H 127 L 90 P 35 H 127 L 45 P 45 H 127 L 45 P 35 H 127	 L 90 P 45 H 210 L 90 P 35 H 210 L 45 P 45 H 210 L 45 P 35 H 210
---	---	---