



CONTRACT
ACOUSTIC
FURNITURE
SOLUTIONS
2019



7	PENDRILLON
35	PIVOT
49	LOSANGE
69	STRIPES
163	L&H SOFA
201	ASSEMBLAGE

Design: Jérôme Gauthier

CONTRACT FURNITURE SOLUTIONS

JEROME
GAUTHIER
STUDIO



PENDRILLON

Pendrillon is a cell-based organization system. Each cell defines itself as a spatial unit that is partly closed and fully autonomous.

Each of these micro-architectures provides an organizational infrastructure designed to meet employees' needs in a multipurpose work environment, thus offering semi-closed individual offices as well as open collective meeting areas.

A flexible and sustainable furniture solution for changing and nomadic work environments.



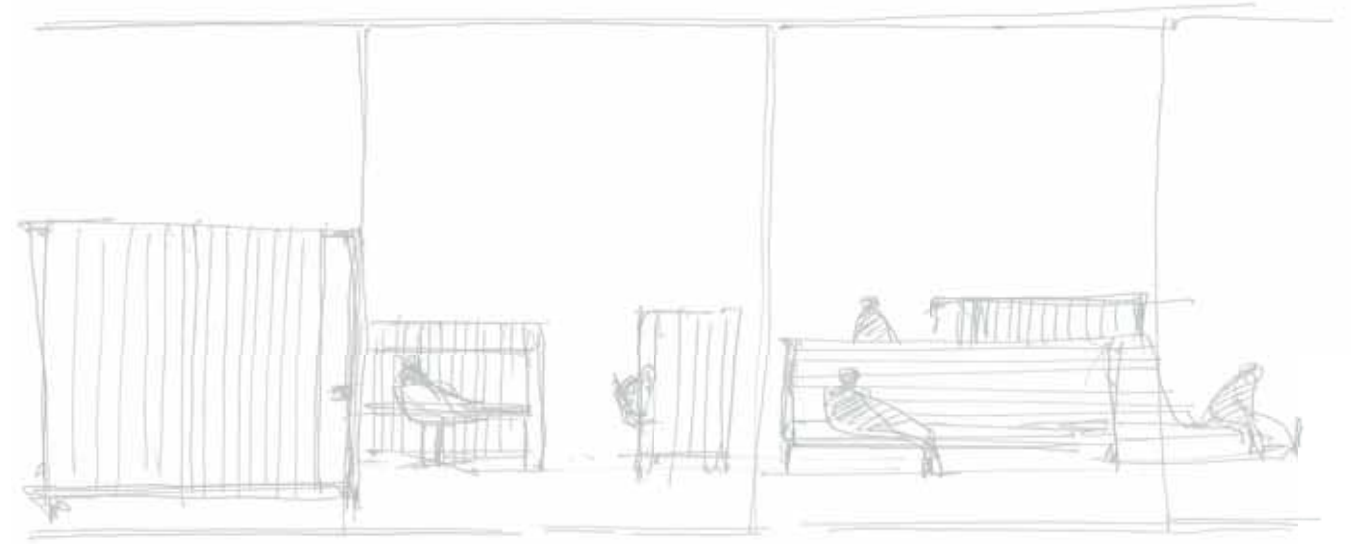
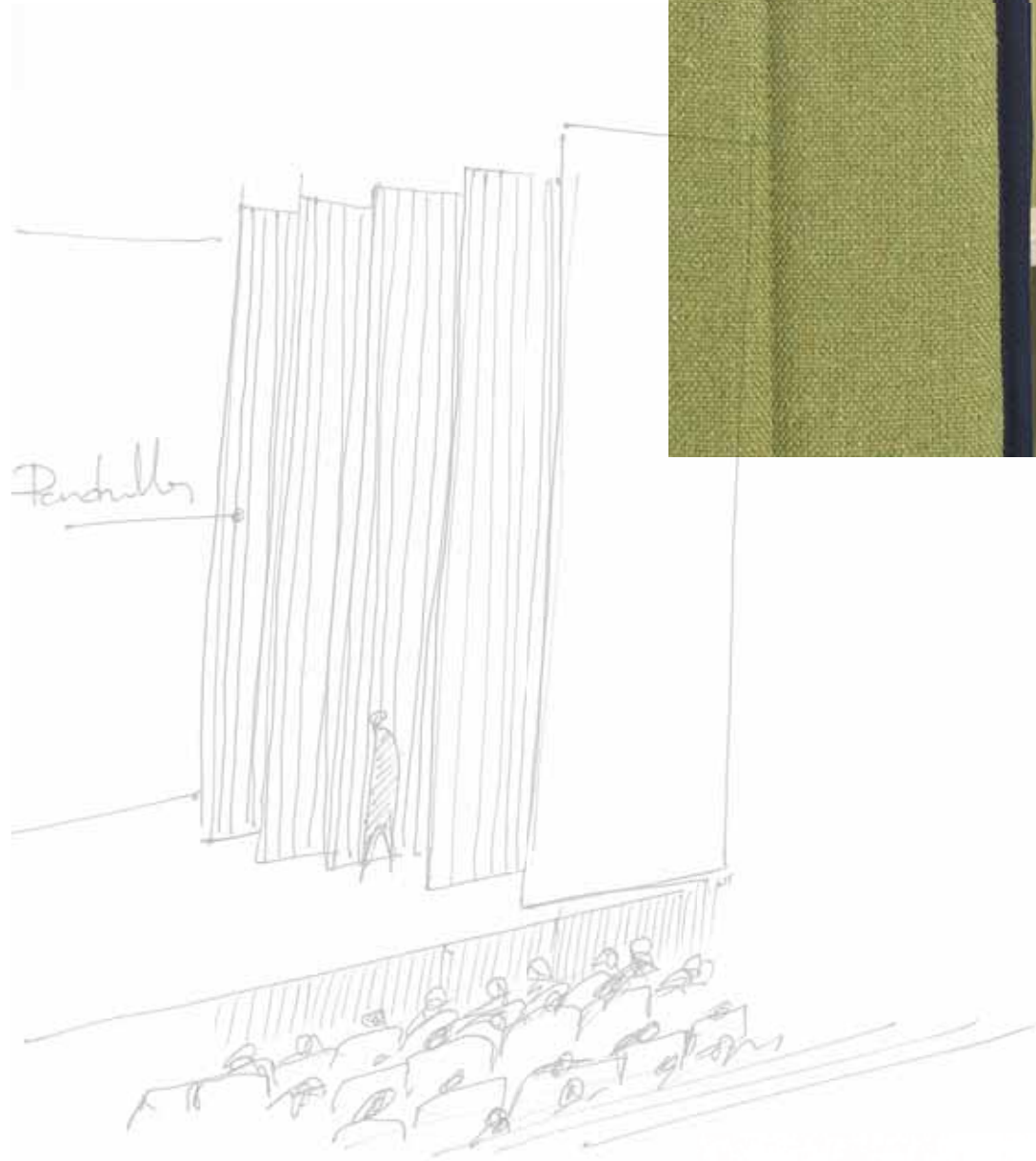

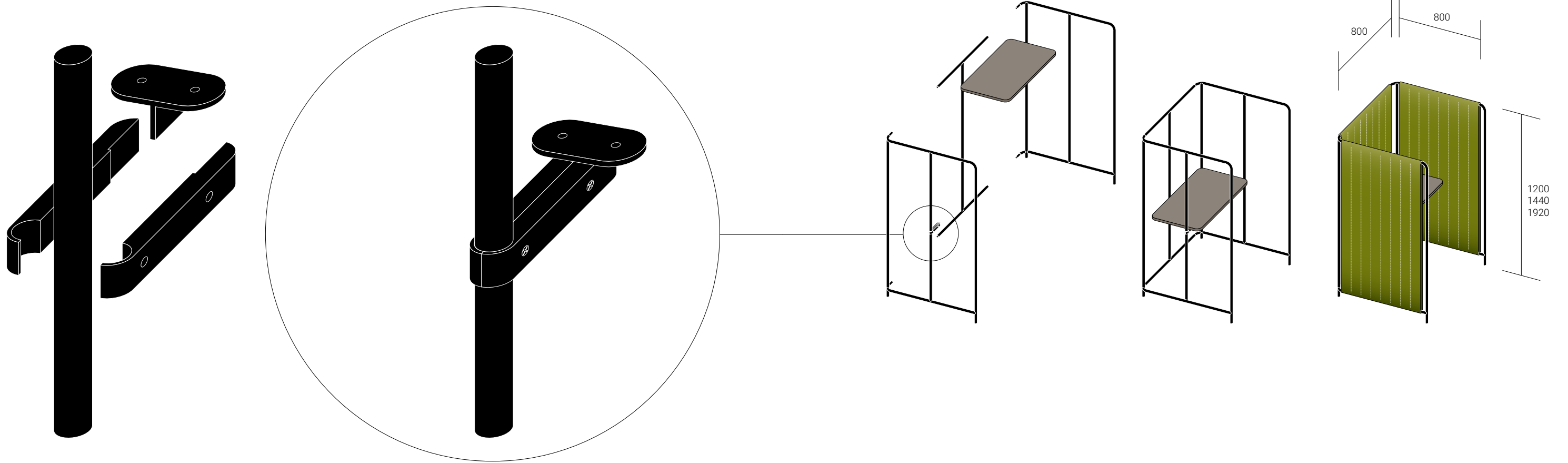

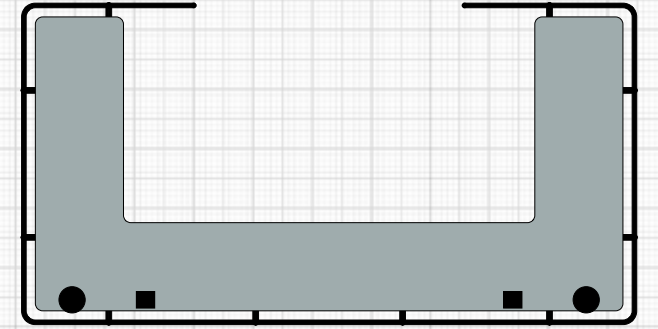
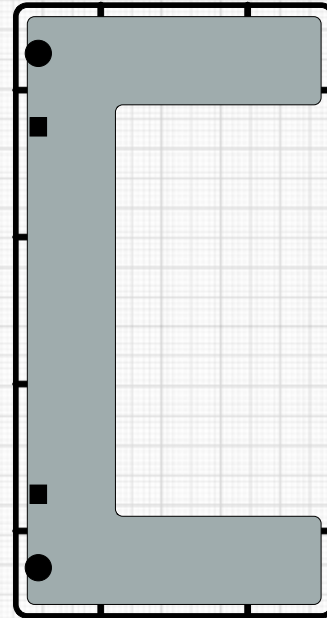
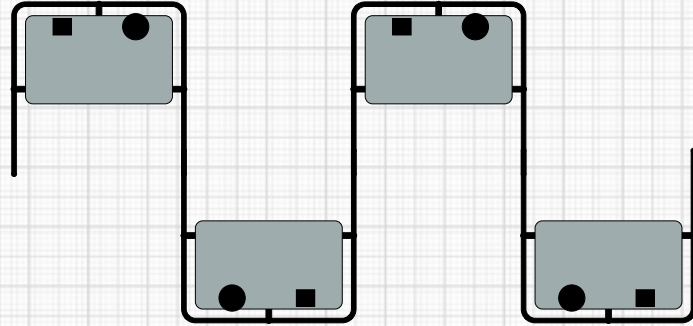
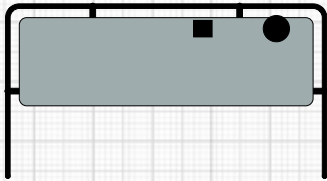
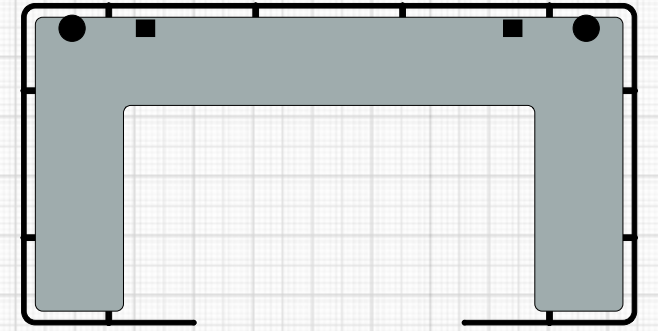
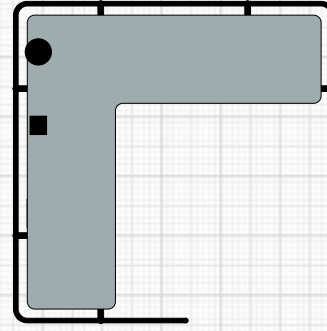
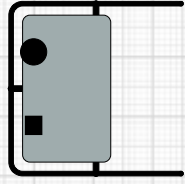

90°

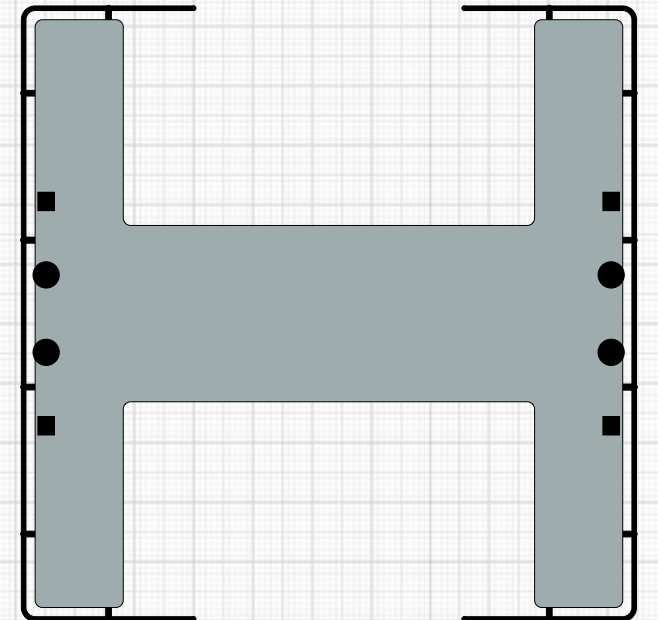
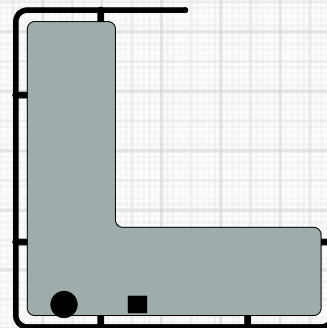
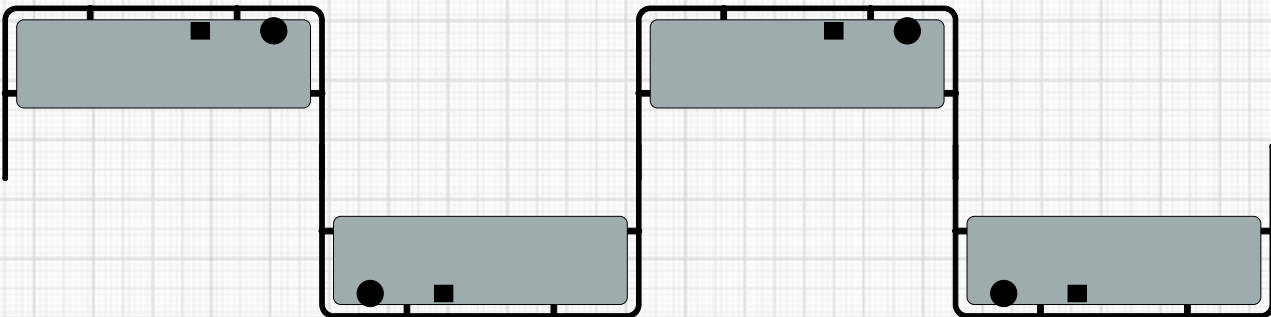
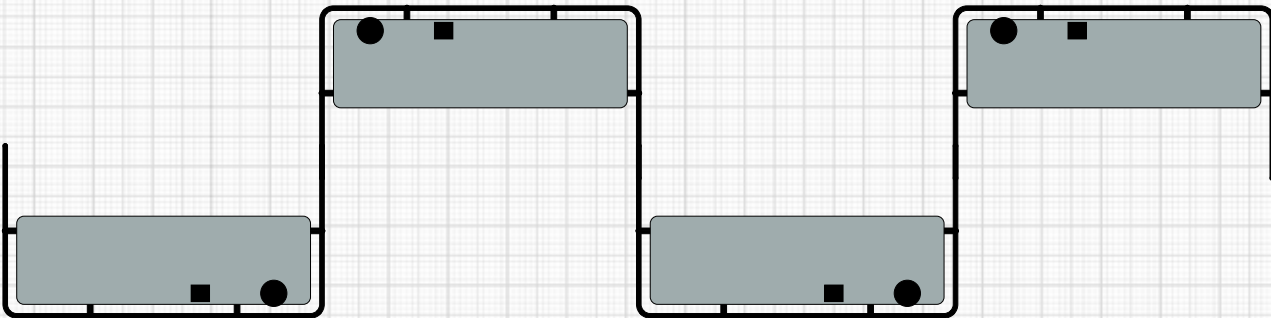





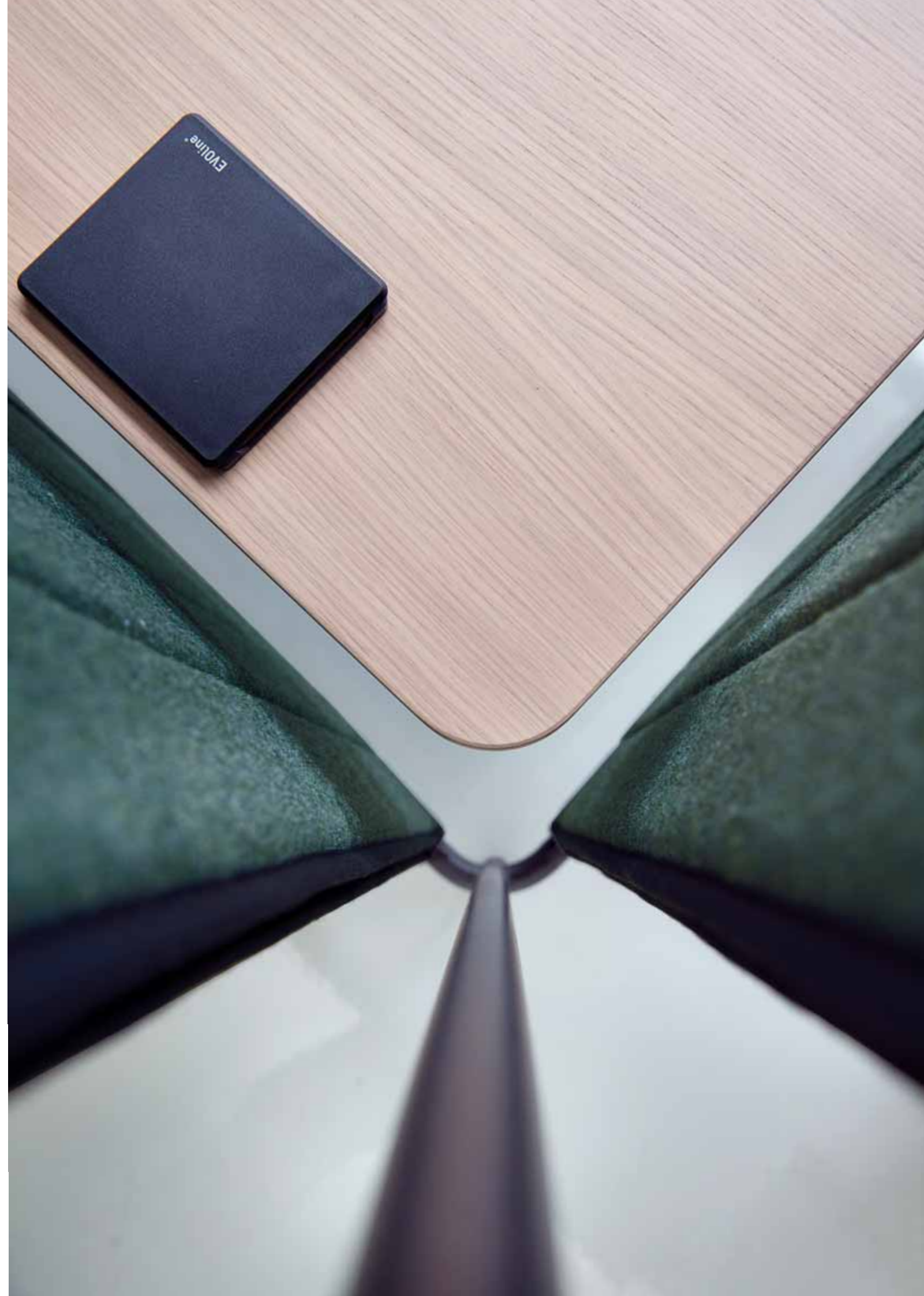





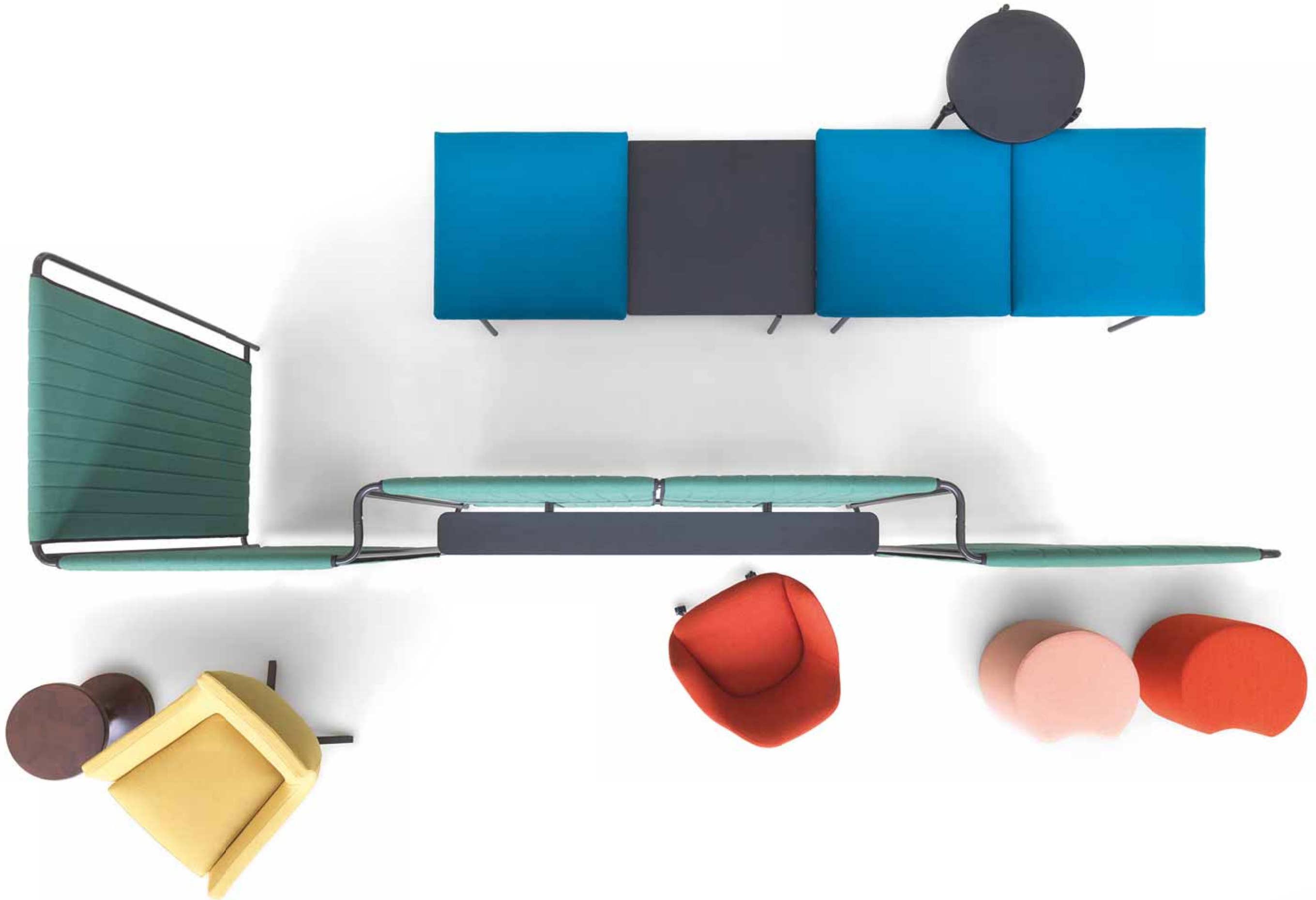



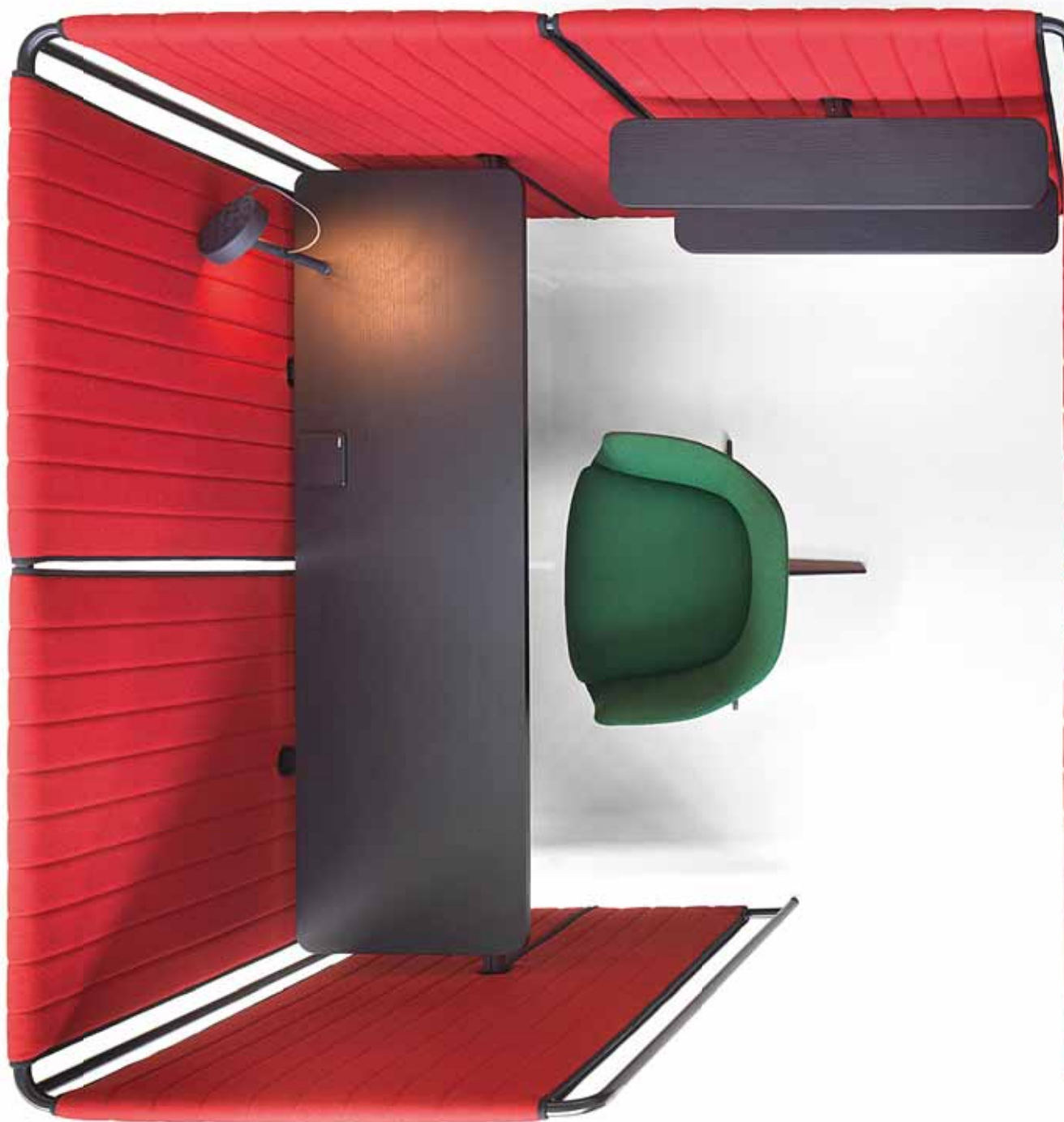

PENDRILLON

DESIGN JÉRÔME GAUTHIER
2018

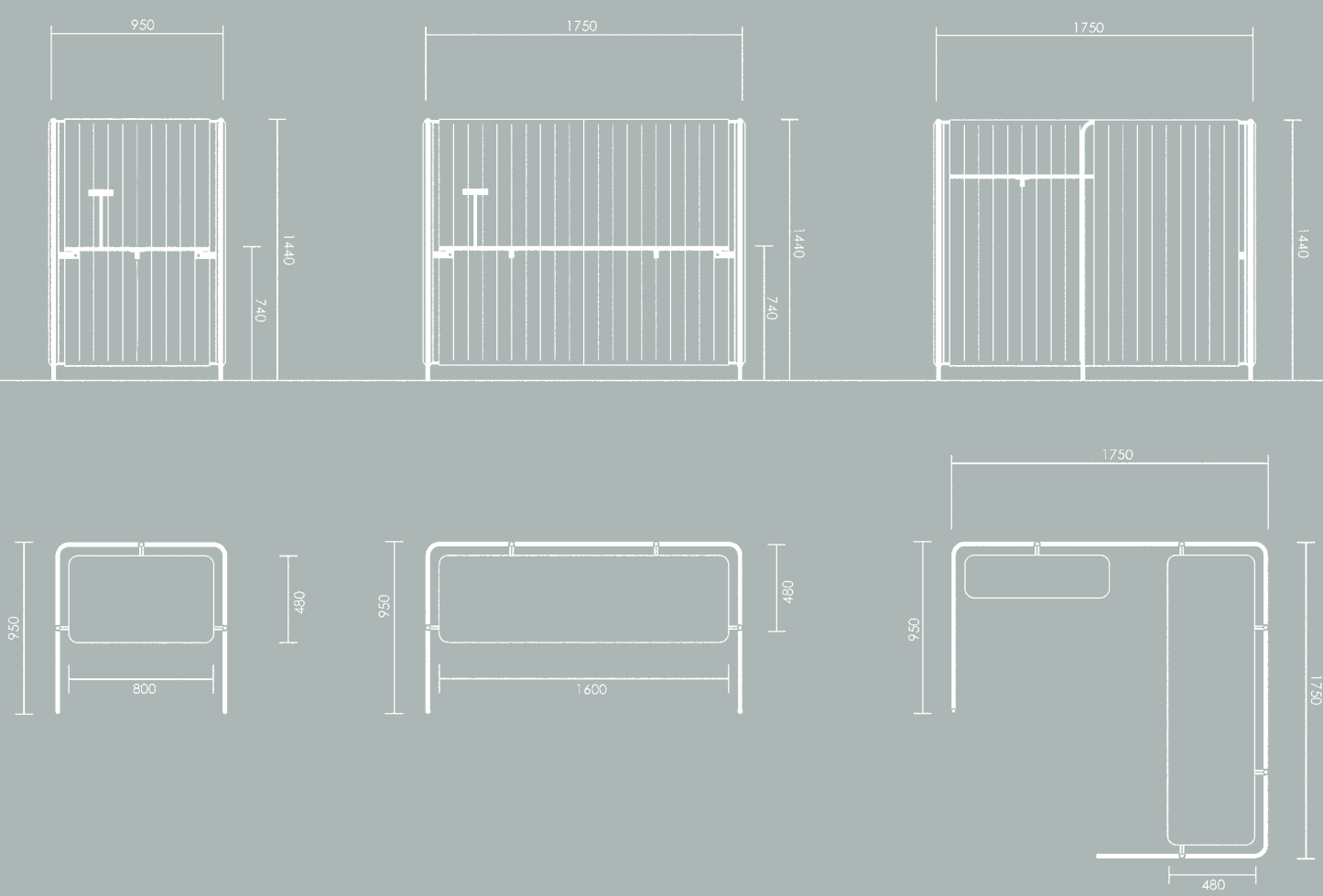

Elements



9PEN101
Single central element
L70 H144

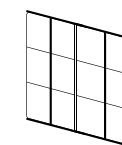

9PEN102
Double central element
L150 H144



9PEN103
Joining element
L12 P12 H144

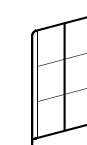

9PEN104
Side element with right joint
L95 H144



9PEN105
Side element with left joint
L95 H144

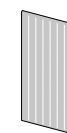

9PEN201
Quilted fabric panel

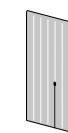

9PEN202
Quilted fabric panel for one plier

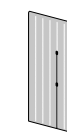

9PEN203
Quilted fabric panel for two pliers

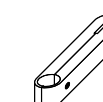

9PEN106
Plier



9PEN301
Shelf
L160 P48 H2



9PEN302
Shelf
L160 P16 H2



9PEN303
Shelf
L80 P48 H2



9PEN304
Shelf
L80 P16 H2



9PEN401
Armchair with low back
L95 P95 H90

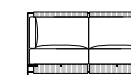

9PEN402
Sofa with low back
L175 P95 H90

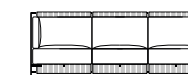

9PEN403
Sofa with low back
L255 P95 H90

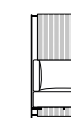

9PEN404
Armchair with high back
L95 P95 H144



9PEN405
Sofa with high back
L175 P95 H144



9PEN406
Sofa with high back
L255 P95 H144

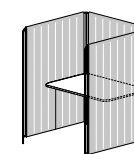

9PEN501
L95 P95 H144

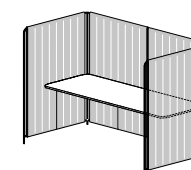

9PEN502
L175 P95 H144

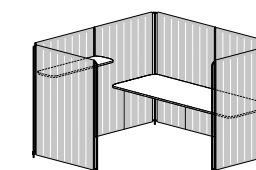

9PEN503
L175 P175 H144

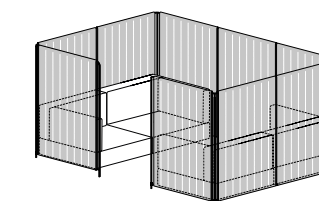

9PEN504
L260 P175 H144

PENDRILLON

DESIGN JÉRÔME GAUTHIER
2018

Optionals



9SS802 *
L10 H10
Schulte Evoline



9SS805
Ø14 H32
Beluxe lamp



9SS811
Castors

*
The standard kit is available with 1 Schuko,
1 USB and 1 RJ45 socket, exclusively
according to the European standards.

Finishes

Standard finish
for metal parts



RAL 9017 black
painted metal
OPM6

Code

Optional finishes
for metal parts

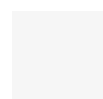

RAL 9016 white
painted metal
OPM7

Code



Metal painted
in RAL Classic
colors
OPM8



Classic bronze
painted metal
OPM9



Golden beach
painted metal
OPM10



Gold pearl
painted metal
OPM11



Anodized
Bronze metal
OPM18

Sistema modulare con struttura in tubolare di metallo verniciato RAL 9017 nero traffico, costituito da divani e pareti mobili attrezzate rivestite con pannelli di tessuto trapuntato dotati di cerniere di chiusura. Mensole e divani sono fissati alle pareti per mezzo di apposite pinze.

I cuscini di seduta e schienale del divano sono inseriti in una struttura di metallo, con cinghie elastiche intrecciate.

Cuscini di seduta sono costituiti da un inserto in poliuretano espanso a quote differenziate di 30 kg/m³ e 40 kg/m³, ricoperto da un trapuntino di vera piuma imbottito a scomparti*.

Cuscini di schienale in poliuretano espanso con densità di 30 kg/m³

Rivestimento non sfoderabile.

Su richiesta i pezzi sono disponibili con rotelle.

*Manutenzione dei cuscini contenenti piuma:

I cuscini contenenti piuma tendono a deformarsi con l'utilizzo.

Per mantenerne la forma è necessario, anche dopo un breve utilizzo, battere e sprimacciare ripetutamente i cuscini. Non utilizzare mai battipanni o aspirapolvere. A coloro che non desiderassero seguire queste indicazioni o che volessero un divano dall'aspetto meno vissuto, raccomandiamo di preferire dei cuscini in gomma.

Modular system with metal tube frame, painted in colour RAL 9017 traffic black, made of sofas and equipped mobile walls, covered with quilted fabric panels, provided with zippers. Shelves and sofas are fixed to the walls by means of specific pliers.

The seat and back cushions are inserted into a metal structure, with interwoven elastic belts.

The seat cushions are made of a polyurethane foam insert in different densities of 30 kg/m³ e 40 kg/m³, covered with a feather compartments quilt*.

The back cushions are made of polyurethane foam with density of 30 kg/m³.

Covers are fixed.

On demand the Pendrillon pieces can be equipped with castors.

*Maintenance of feather cushions:

Cushions filled with feathers tend to change their shape with use.

In order to keep their shape it is necessary, even after a short use, to plump up the cushions repeatedly. Never use carpet beater or vacuum cleaner.

We recommend to choose foam cushions to those who do not wish to follow these instructions or to have a "used look" sofa.

Modulares System mit Gestell in Metallrohr, lackiert in der Farbe RAL 9017 verkehrsschwarz, bestehend aus Sofas und beweglichen Wänden, mit abgesteppten Stoffpaneelen bezogen, und mittels Reissverschlüsse geschlossen.

Ablagen und Sofas sind mit besonderen Zangen an den Wänden befestigt.

Sitz- und Rückenissen sind in einem Metallgestell eingebettet, mit geflochtenen Gummigurten.

Die Sitzkissen bestehen aus einem Schaumkern in verschiedenen Dichten von 30 Kg/m³ und 40 Kg/m³ mit einer gekammerten Daunenauflage*.

Die Rückenissen bestehen aus Polyurethan-Schaumstoff in einer Dichte von 30 Kg/m³.

Bezüge immer fix, nicht abziehbar.

Auf Anfrage sind die Modelle mit Rollen erhältlich.

*Wartungsanleitungen fuer Daunenissen:

Die Kissen, die Daunen enthalten, neigen dazu, sich durch Gebrauch zu verformen.

Um die urspruengliche Form zu halten, ist es notwendig, auch nach kurzem Gebrauch, die Kissen wiederholt aufzuschuettern.

Keinen Ausklopfen oder Staubsauger verwenden.

Unseren Kunden, die diese Anweisungen nicht befolgen moechten, oder die kein Sofa mit solchem "gebrauchten" Aussehen haben moechten, empfehlen wir Polyurethan-Kissen.

Système modulaire avec structure en tube en métal teinté RAL 9017 noir signalisation, constitué de canapés et murs équipés revêtues avec des panneaux de tissu matelassé, équipés de charnières de fermeture. Étagères et canapé sont fixés aux murs au moyen de pinces spécifiques.

Les coussins d'assise et dossier sont insérés dans une structure en métal, avec sangles élastiques entrecroisées.

Coussins d'assise constitués d'un noyau en mousse polyuréthane de différentes densités de 30 kg/m³ et 40 kg/m³, couvert de véritable duvet broché en compartiments*.

Coussins de dossier en mousse polyuréthane d'une densité de 30 kg/m³.

Le revêtement est toujours fixe.

Sur demande, les pièces sont disponibles avec roulettes.

*Entretien de coussins en duvet:

Coussins en duvet ont tendance à perdre leur forme dû à l'usage.

Pour en conserver la forme il est nécessaire, aussi après un usage court, de régulièrement battre les coussins. Ne jamais utiliser la tapette ou l'aspirateur.

À ceux qui ne désirent pas suivre ces indications ou qui souhaitent un canapé qui ait l'air moins "usé", nous conseillons vivement de choisir des coussins en mousse polyuréthane.

PIVOT 2014



The Pivot chair and table are characterized by their flexibility. The Pivot chair is the first seat by Marelli with a swivel function. Made entirely from beech wood, the molded plywood components convey a sense of comfort and tranquility in the seating position.

The upholstered chair's seat and back, available in a large range of fabrics and colors, are supported by a wooden structure through a rotating mechanism fitted to the legs.

This circular movement enables easy rotating and circulation from one space to another. The Pivot table is adjustable in height. The table base, similar to that of the chair, is held by a wooden screw fixed in the table top.

The tabletops, available in two dimensions, can be adjusted up and down. They are suitable for all horizontal uses, from a coffee table, side table to a meeting table. An object that is fully functional thanks to its flexible use.

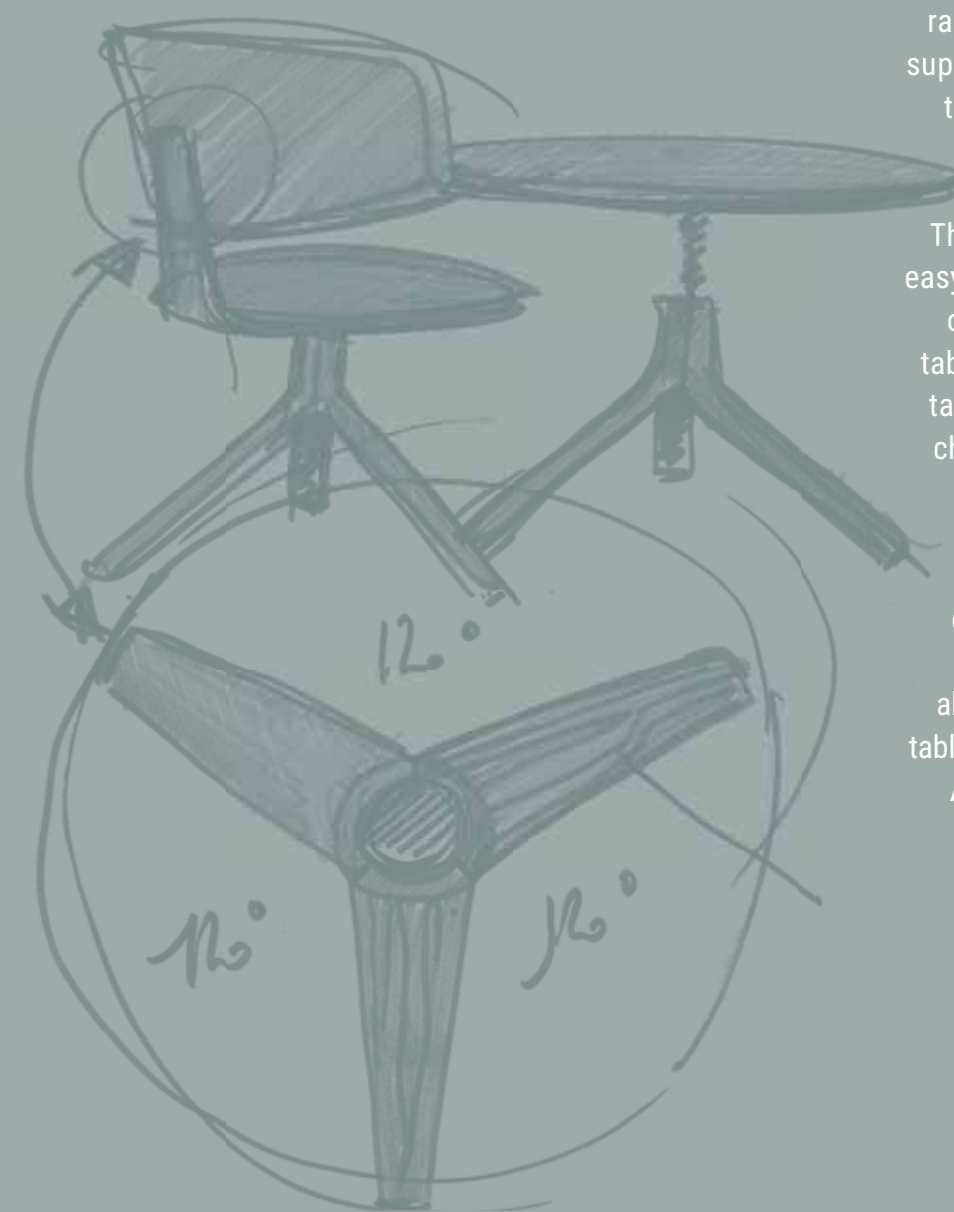

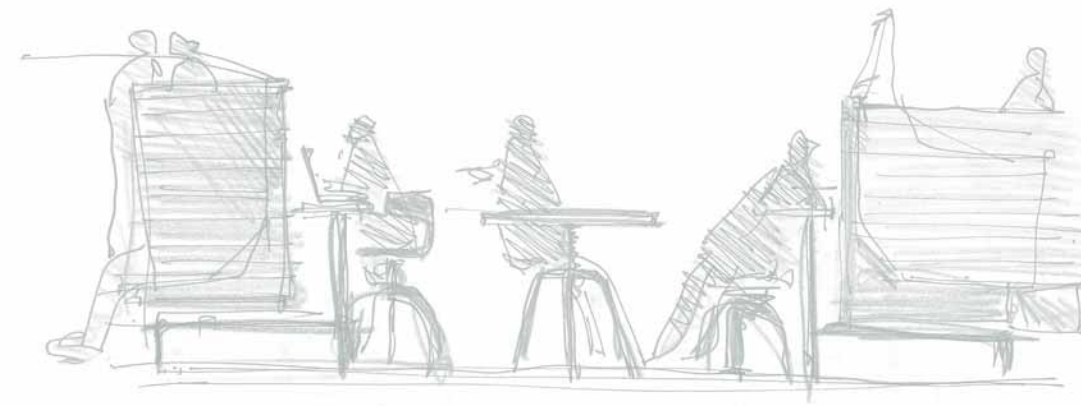
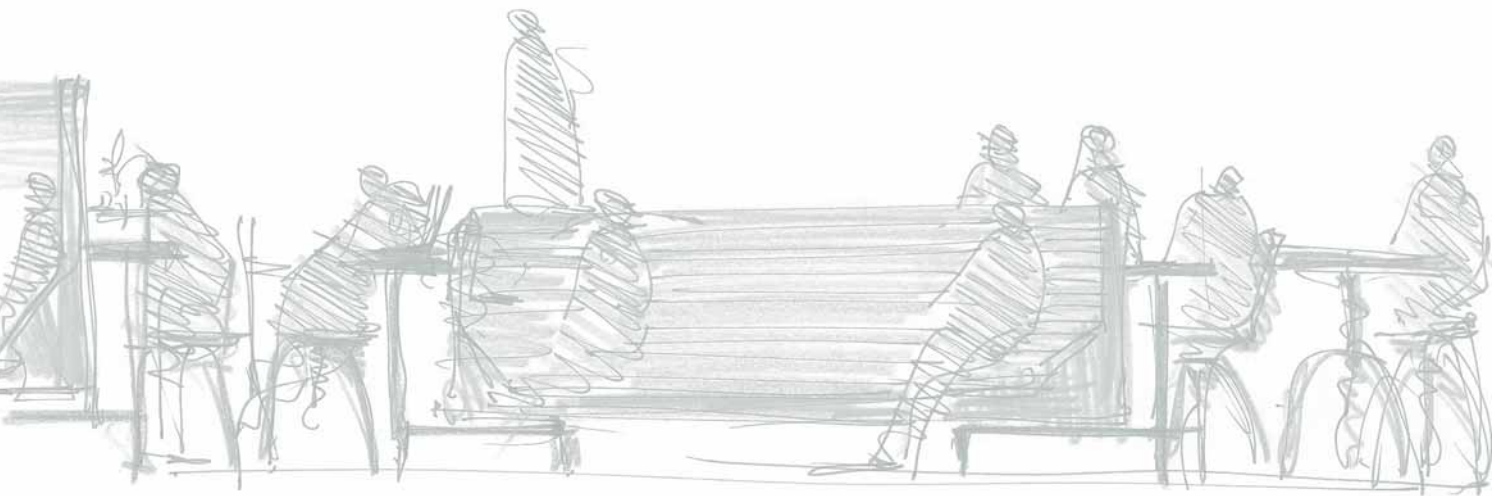









PIVOT

DESIGN JÉRÔME GAUTHIER
2014

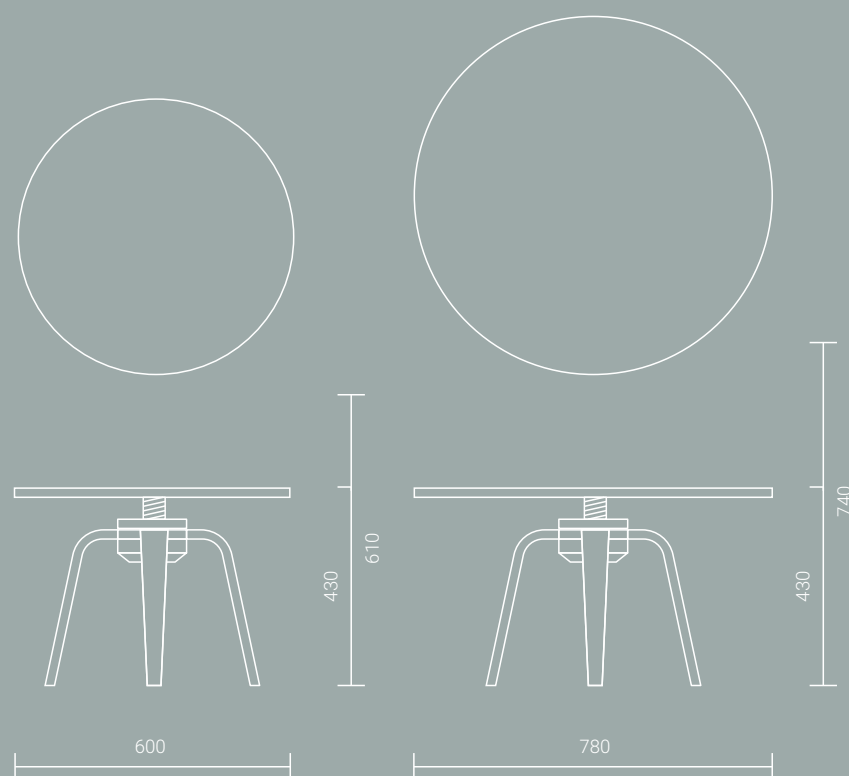
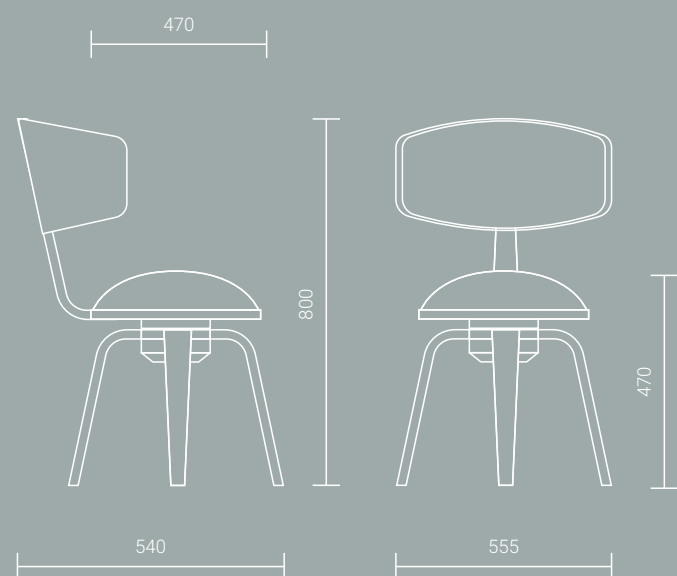

Armchairs



9PIV101
L55,5 P54 H80
Swivel armchair

Poltroncina
Struttura in multistrato di faggio impiallacciato rovere.
Spessore della gamba 20 mm.
Imbottitura della seduta e dello schienale in poliuretano espanso densità 30 kg/m³, rivestito in dacron.
Il rivestimento è sempre fisso.
Lucidatura con finitura opaca a poro aperto.
Antiscivolanti in plastica dura.

Tavolini
Base in multistrato di faggio impiallacciato rovere.
Spessore della gamba 20 mm.
Piano in multistrato di pioppo impiallacciato rovere, spessore 18 mm.
Lucidatura con finitura opaca a poro aperto.
Antiscivolanti in plastica dura.

Fauteuil
Structure en multiplis de hêtre plaqué chêne.
Épaisseur du pied 20 cm.
Rembourrage de l'assise et du dossier en mousse de polyuréthane densité 30 kg/m³, revêtue de dacron.
Le revêtement est toujours fixe.
Teinture à pores ouverts finition mate.
Patins en plastique dur.

Tables basses
Piètement en multiplis de hêtre plaqué chêne.
Épaisseur du pied 20 cm.
Plateau en multiplis de peuplier plaqué chêne, épaisseur 18 mm.
Teinture à pores ouverts finition mate.
Patins en plastique dur.

Finishes

Oak finishes

Code

Code



Cherry stained oak **OPR1** Wengé stained oak **OPR2** Walnut stained oak **OPR3** Natural oak **OPR4** Black stained oak **OPR5** Cherry Milano stained oak **OPR6**



Tobacco stained oak **OPR8** Grey taupe stained oak **OPR9** Whitened oak **OPR10** Charcoal stained oak **OPR11** Mahogany stained oak **OPR12** Oak painted in RAL Classic colours **OPR14** Moka matt stained oak **OPR15**

Tables



7PIV101
ø60 H43/61

Armchair
Frame in oak veneered beech plywood.
Leg 20 mm thick.
Seat and back upholstered with polyurethane foam with density 30 kg/m³, covered with dacron.
Fixed covers.
Open-pore staining with matt finish.
Glides in hard plastic.

Tables
Base in oak veneered beech plywood. Leg 20 mm thick.
Top in oak veneered poplar plywood, 18 mm thick.
Open-pore staining with matt finish.
Glides in hard plastic.



7PIV102
ø78 H43/74

Sessel
Das Gestell besteht aus Buchensperrholz mit Eichenholz-Furnier.
Beinstärke 20 mm.
Sitz und Rücken gepolstert mit Polyurethanschaumstoff mit Dichte 30 Kg/m³, mit Dacron ummantelt.
Pivot ist immer festbezogen.
Offenporiges Beizen in matter Ausführung.
Gleiter aus hartem Kunststoff.

Tische
Das Gestell besteht aus Buchensperrholz mit Eichenholz-Furnier. Beinstärke 20 mm.
Tischplatte aus Pappelsperholz mit Eichenholz-Furnier. Plattenstärke 18 mm.
Offenporiges Beizen in matter Ausführung.
Gleiter aus hartem Kunststoff.

LOSANGE 2018

Losange is a modular seating system. Part of an uneven subdivision of the hexagon, each element of this « tangram » is both autonomous and complementary.

The multiple possible compositions offer a wide variety of space configurations with mixed uses.

The graphic vibration of the hatched frames of each removable padded cover adds up to the geometric forms' dynamics. The triangle and diamond shape, available in two heights, increase the number of seating positions, leaning position and upright position.

An intuitive, multiform and extensible furniture solution.

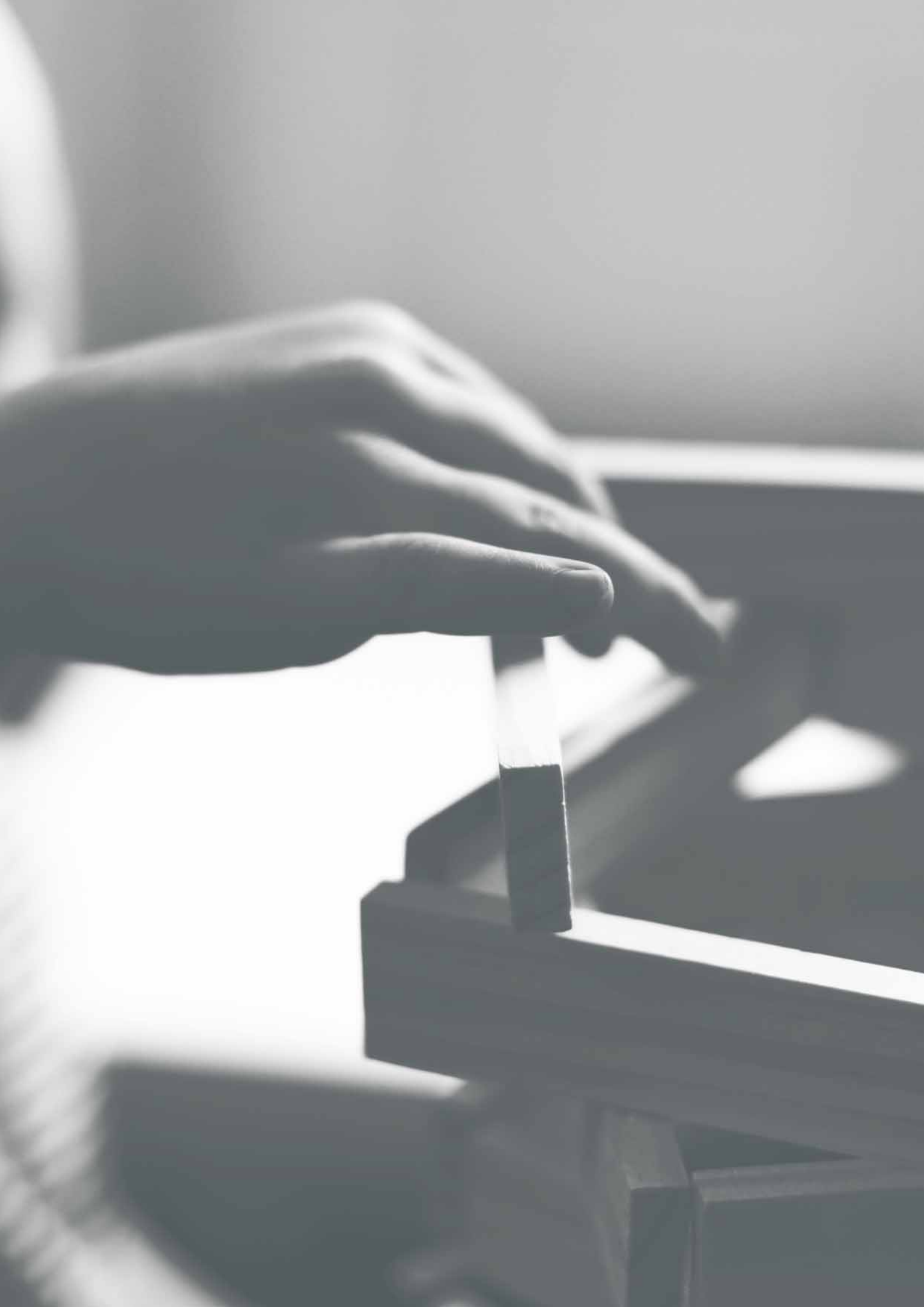

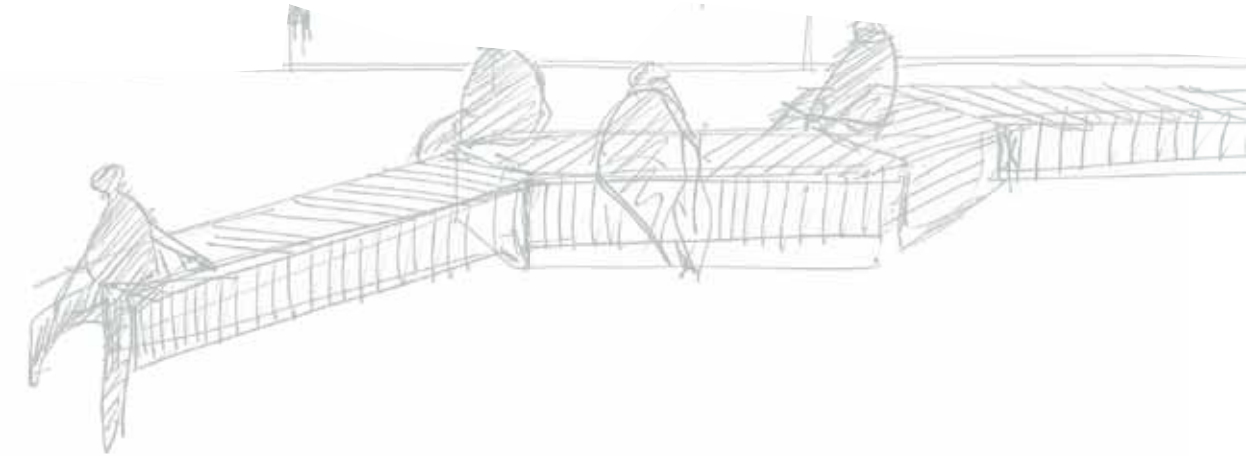
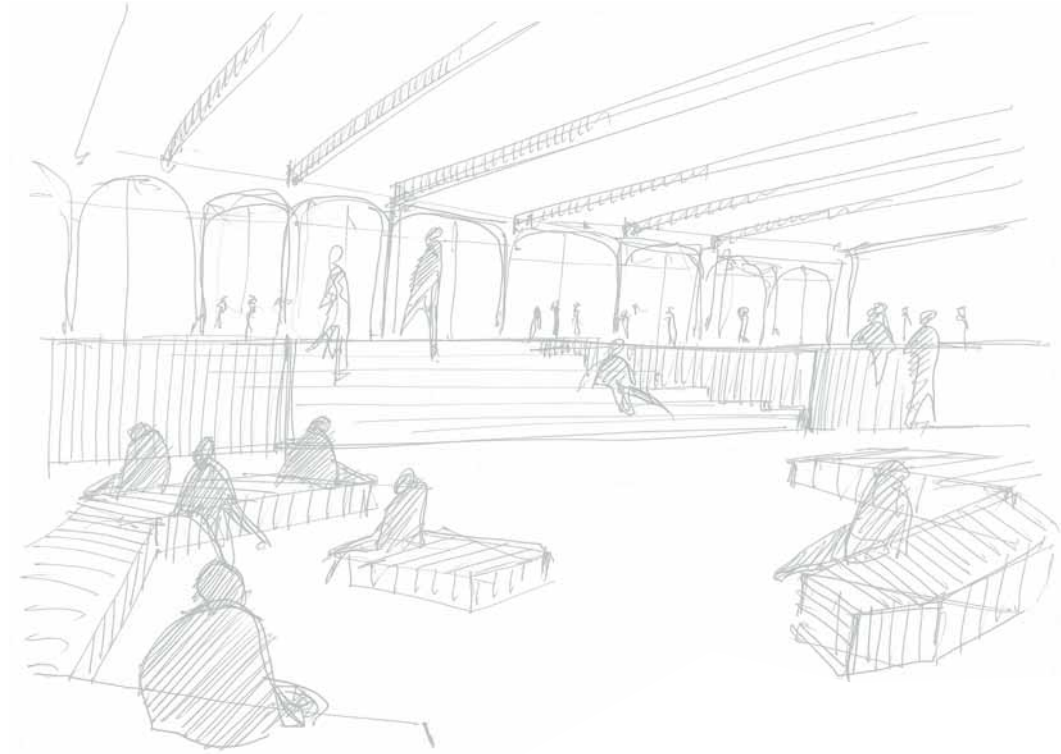
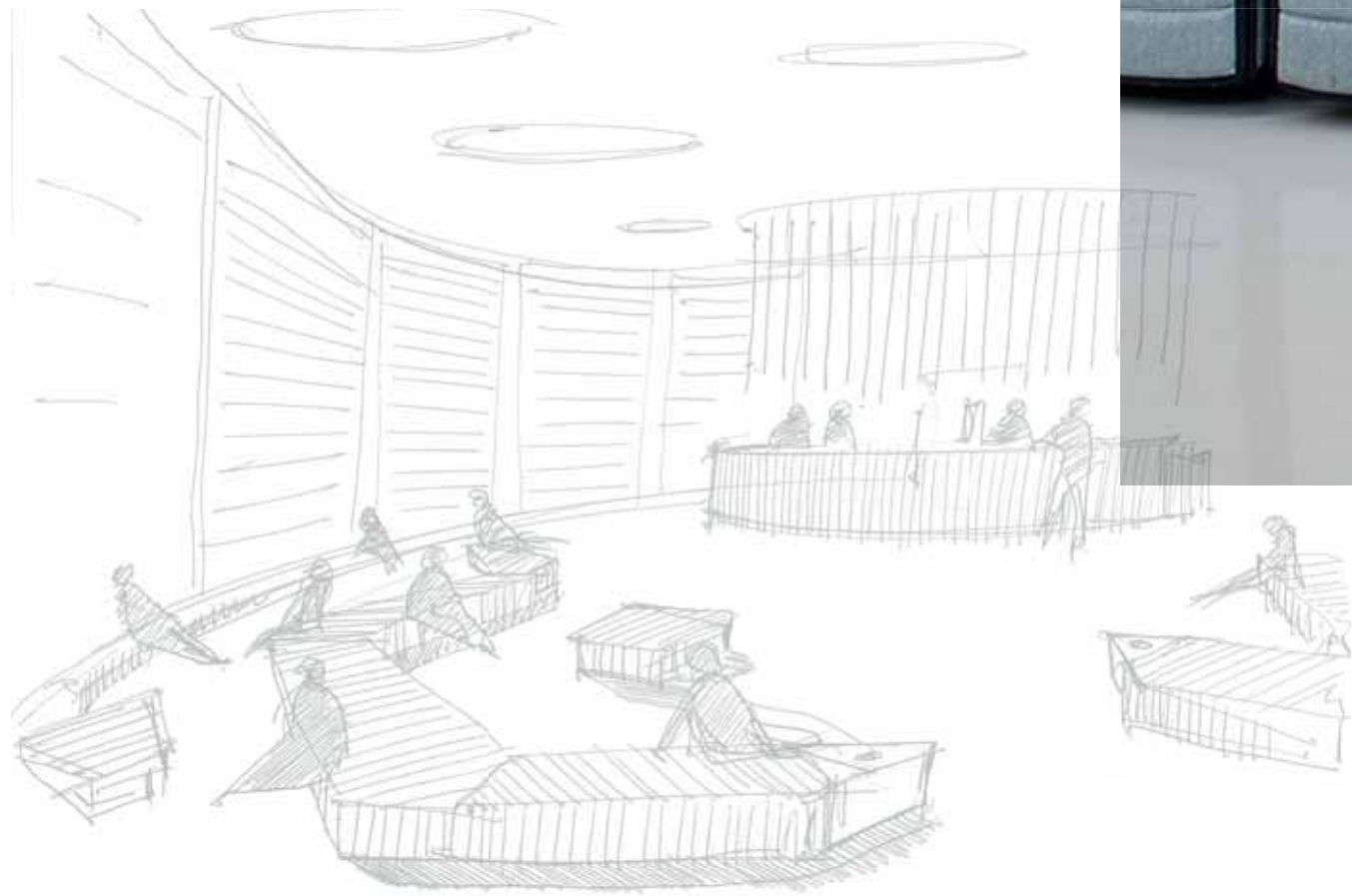

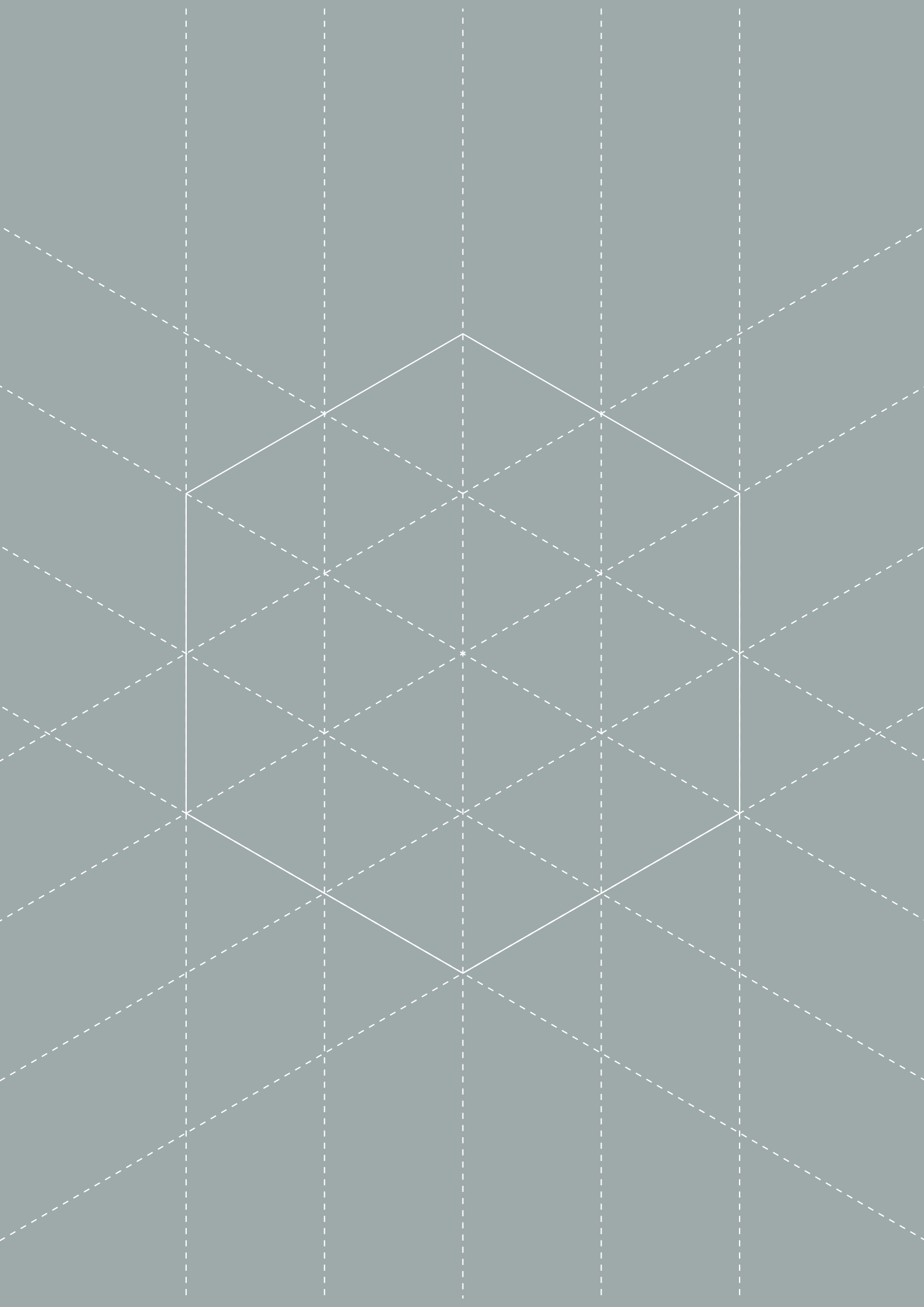

60°

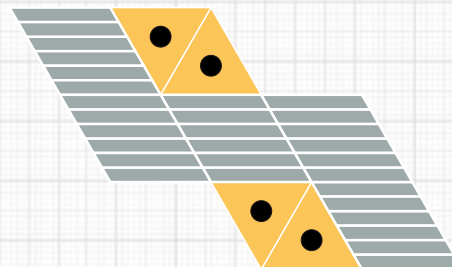
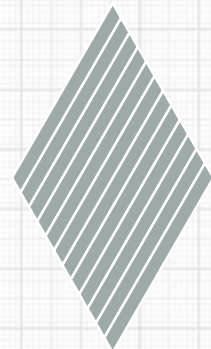
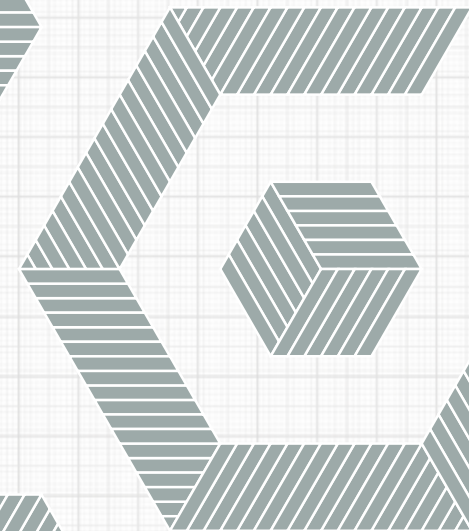
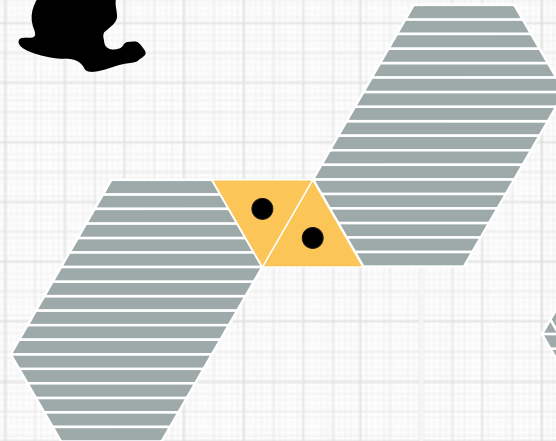
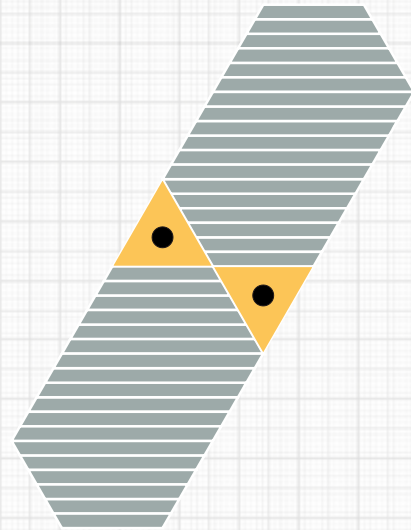
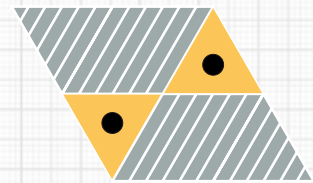
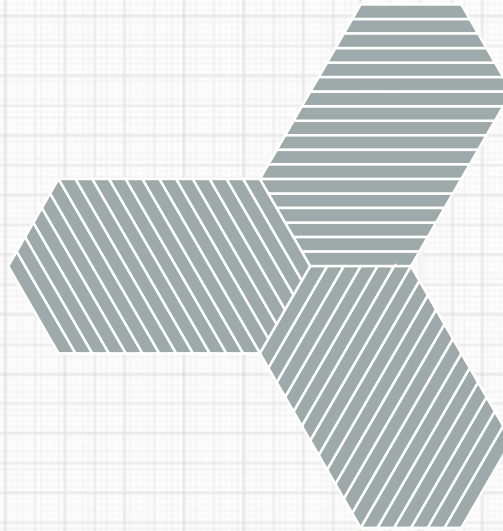
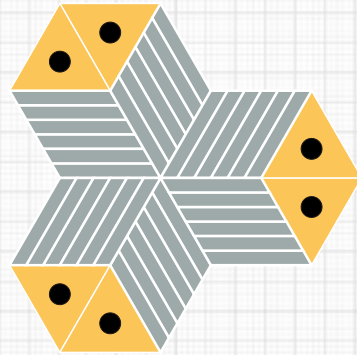
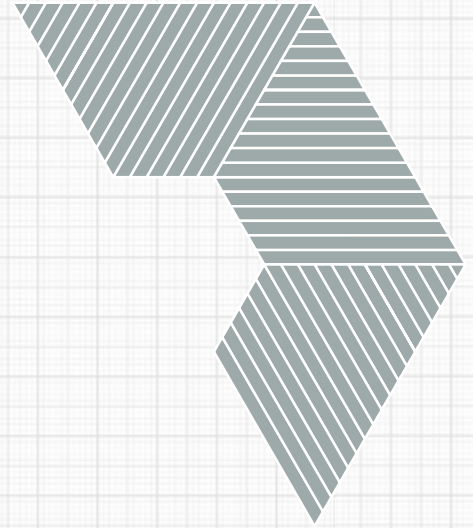
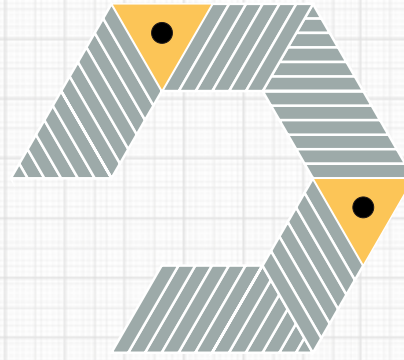
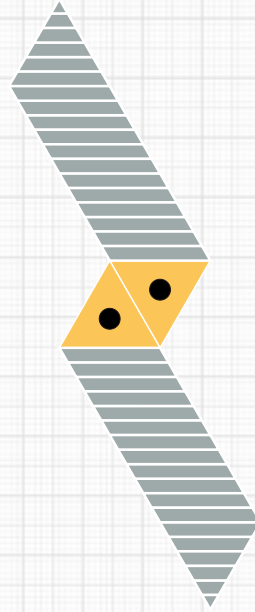
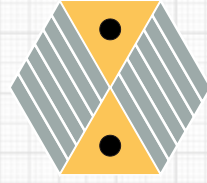









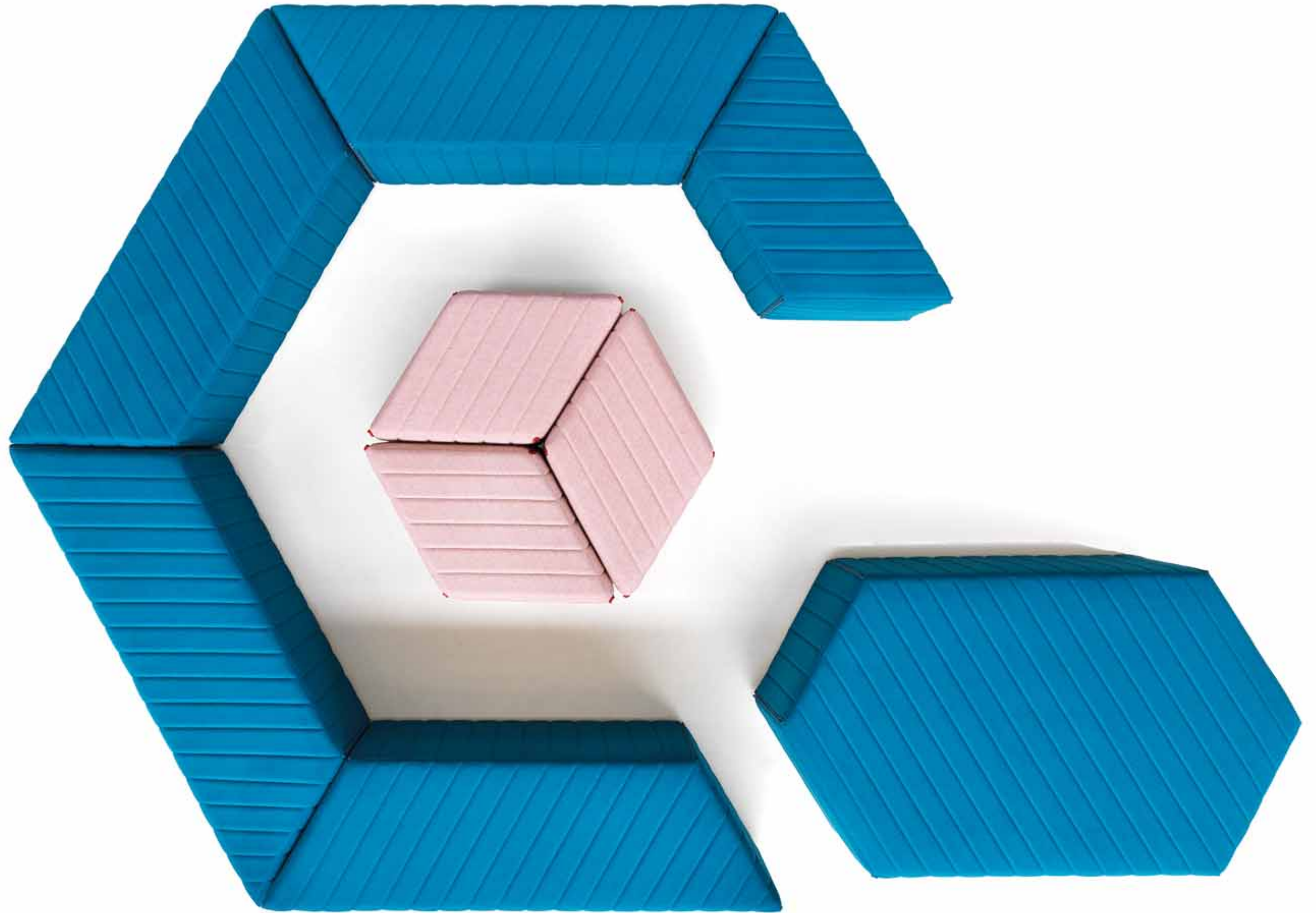

LOSANGE

DESIGN JÉRÔME GAUTHIER
2018

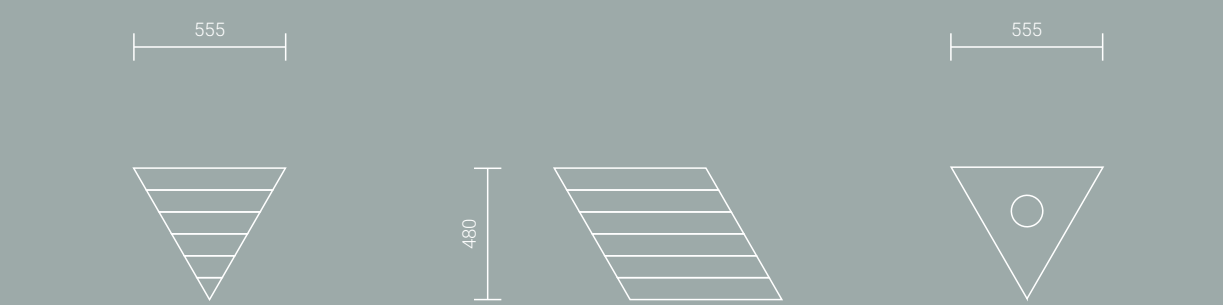
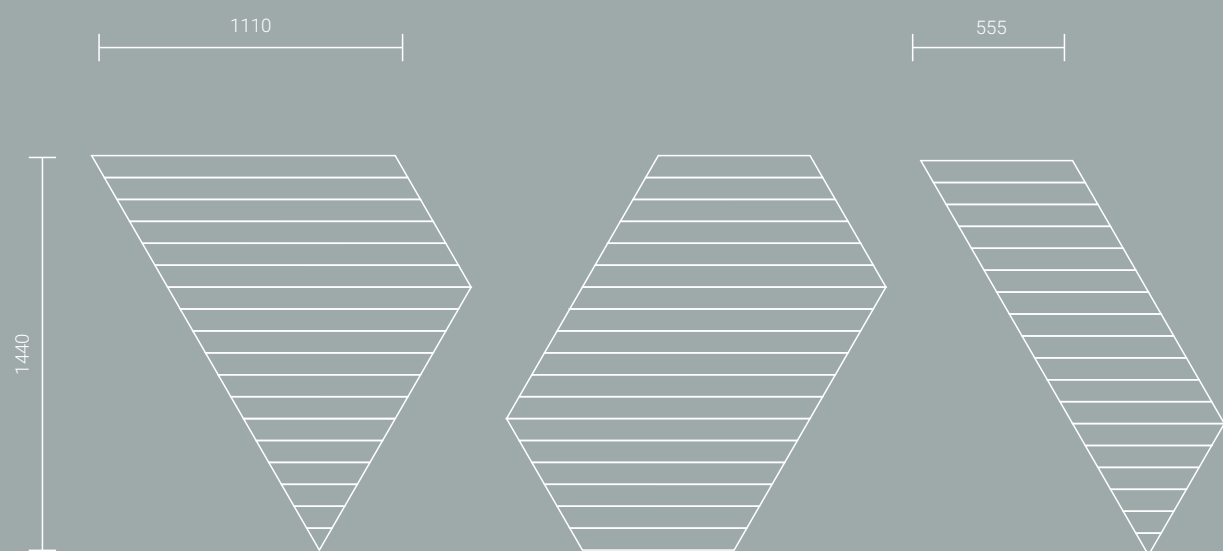
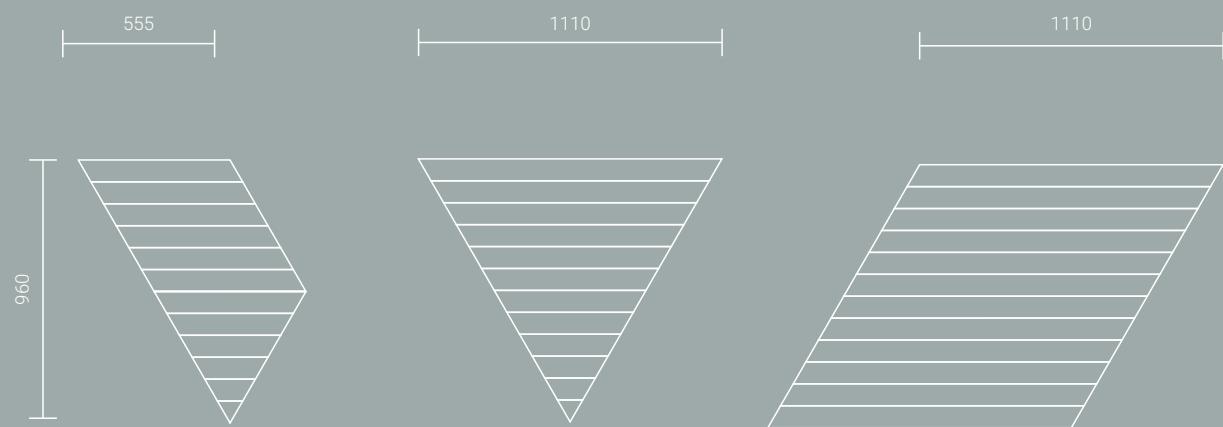

Sofas

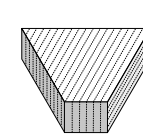

9LOS101
Seat element
L166 P96 H40

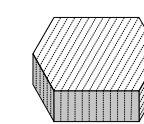

9LOS102
Seat element
L166 P96 H40

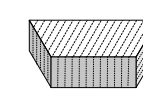

9LOS103
Seat element
L166 P48 H40

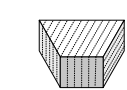

9LOS104
Seat element
L111 P48 H40

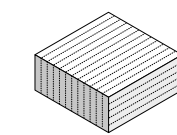

9LOS105
Seat element
L166 P96 H40



9LOS106
Seat element
L83 P48 H40

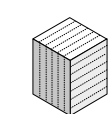

9LOS107
Backrest element
L83 P48 H72

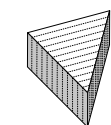

9LOS108
Seat element
L111 P96 H40

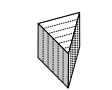

9LOS109
Seat element
L56 P48 H40



9LOS110
Seat element
with Bachmann Twist
electric socket
L56 P48 H40

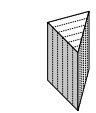

9LOS111
Backrest element
L56 P48 H72

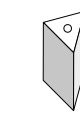

9LOS112
Backrest element
with Bachmann Twist
electric socket
L56 P48 H72

Fusto in legno di abete massello e pannelli in multistrato. La seduta, priva di cinghie elastiche intrecciate, è in poliuretano espanso con una densità di 40 kg/m³, 5,9 kPa, con rinforzi con densità 75 kg/m³. Le caratteristiche righe orizzontali o verticali sono ottenute tramite una trapuntatura che accoppia non solo il rivestimento e il dacron, ma anche uno strato di gomma con uno spessore di 1 cm. Ogni riga è alta 8 cm. Nella versione standard il rivestimento è sfoderabile, ma è prevista anche una versione non sfoderabile senza trapuntatura. Profilo in GROS GRAIN, colore standard nero. I vari pezzi sono agganciati con l'ausilio di ganci o baionette.

Carcasse en sapin massif et panneaux de multiplis. L'assise, sans sangles élastiques entrecroisées, est en mousse de polyuréthane d'une densité de 40 kg/m³, 5,9 kPa, avec des renforcements d'une densité de 75 kg/m³. Les caractéristiques rayures horizontales ou verticales sont obtenues à travers un matelassage qui accouple non seulement le revêtement et le dacron, mais aussi une couche de mousse d'épaisseur de 1 cm. Chaque raie est haute 8 cm. Dans la version standard le revêtement n'est pas déhoussable, mais il est prévue aussi une version non déhoussable sans matelassage. Passepoil en GROS GRAIN, la couleur standard est noir. Toutes les pièces sont fixé à l'aide de crochets ou de fixations à baionette.

Frame made of solid pine wood and plywood panels. The seat, without interwoven elastic belts, is made of polyurethane foam with a density of 40 kg/m³, 5,9 kPa, with supports with a density of 75 kg/m³. The characteristic horizontal or vertical stripes are obtained from a quilting coupling not only the cover material with dacron, but also with a foam layer 1 cm thick. Every stripe is 8 cm high. The standard version has removable covers, but it is also possible to have a version with fixed covers, without quilting. Piping in GROS GRAIN, black is the standard colour. The different pieces are fixed with hooks or bajonet fittings.

Каркас выполнен из массива ели в сочетании с многослойной фанерой. Сиденье без подвески из эластичных перекрещивающихся ремней покрыто вспененным полиуретаном плотностью 40 кг/м³ 5,9 кПа и прослойкой плотностью 75 кг/м³. Характерные горизонтальные либо вертикальные полосы образованы декоративной простежкой, соединяющей между собой обивку, подложку из дакрона и слой из полиуретана толщиной 1 см. Расстояние между полосами 8 см.

Das Gestell besteht aus massiver Fichte und Schichtholzplatten. Die Sitzoberfläche, ohne geflochtene Gummigurten, besteht aus Polyurethan-Schaumstoff mit einer Dichte von 40 Kg/m³, 5,9 kPa, mit Verstärkungen mit einer Dichte von 75 Kg/m³. Die kennzeichnenden horizontalen oder vertikalen Streifen bekommt man durch eine Absteppung, die nicht nur das Bezugsmaterial mit Dacron koppelt, sondern auch mit einer Schaumschichte mit einer Dicke von 1 cm. Jede Streife ist 8 cm hoch. Bei der Standard Version sind die Bezüge abziehbar, aber vorgesehen wird auch eine festgeposterte Version ohne Absteppung. Keder in GROS GRAIN, die Standard-Farbe ist schwarz. Die verschiedenen Teile werden durch Haken oder Bajonettverschlüsse.

В стандартном исполнении чехлы съёмные, при этом также предусмотрена версия без простёжки и с несъёмными чехлами. Кант из гросгрена, в стандартном исполнении черного цвета. Отдельные модули крепятся между собой при помощи специальных крючков либо штифтов.



STRIPES 2008

The bench, a collective seating furniture by nature, lies at the core of the Stripes sofa concept. From slats to upholstered covers, this piece of furniture embodies with style the archetype. It also offers a unique touch thanks to the back cushion.

Modules can be linear, curvilinear, closed, with adjustable back height, with or without armrest.

They can offer various combinations: face to face, side by side depending on orthogonal and hexagonal stripes. The sofa becomes a work station when adding a shelf on the backrest at the rear. Therefore, the combined augmented modules provide ideal configurations for multimedia collaborative space.

When used independently or combined in a flexible manner, Stripes components allow for multipurpose work environments suitable for all staff to perform their tasks.

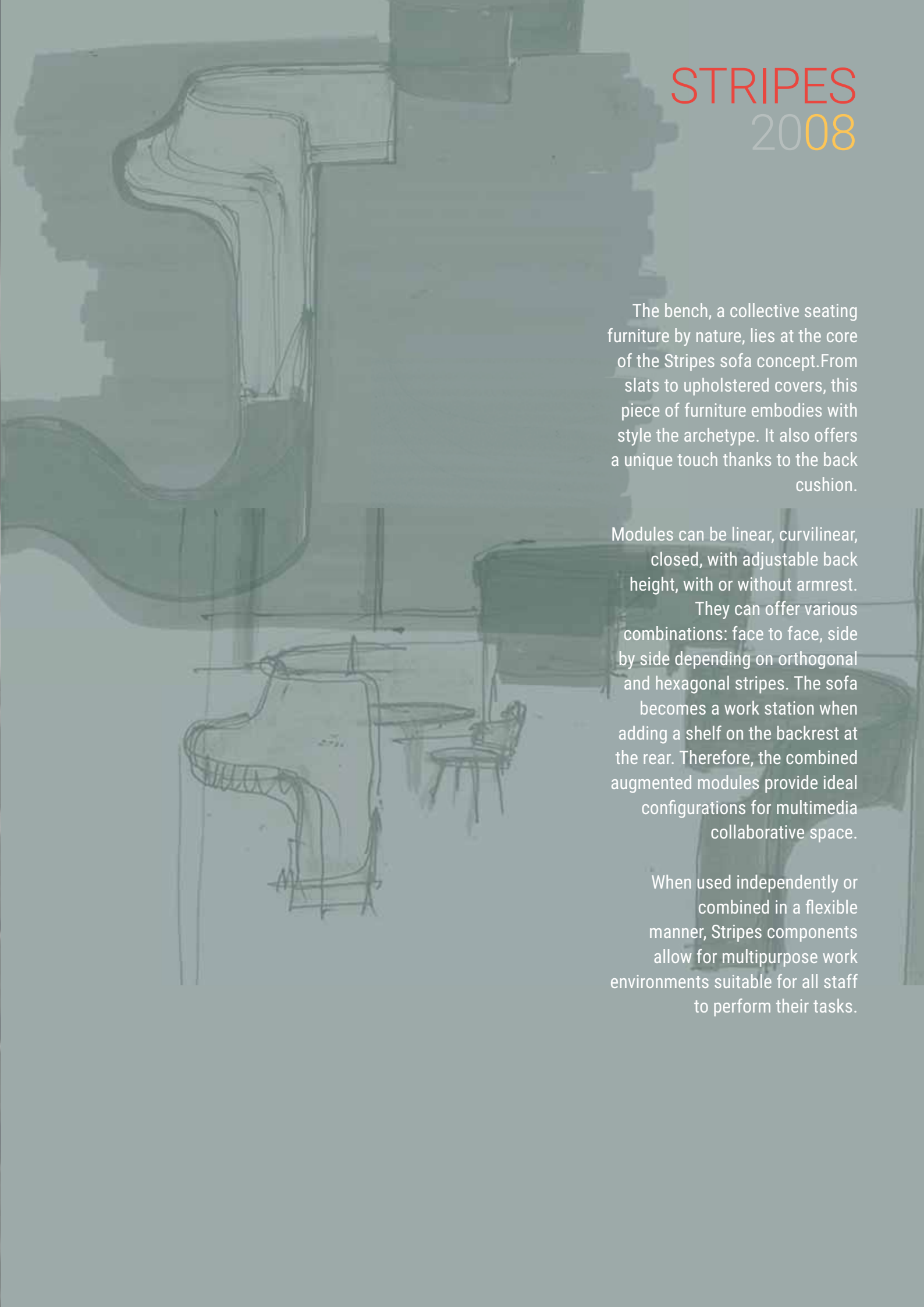

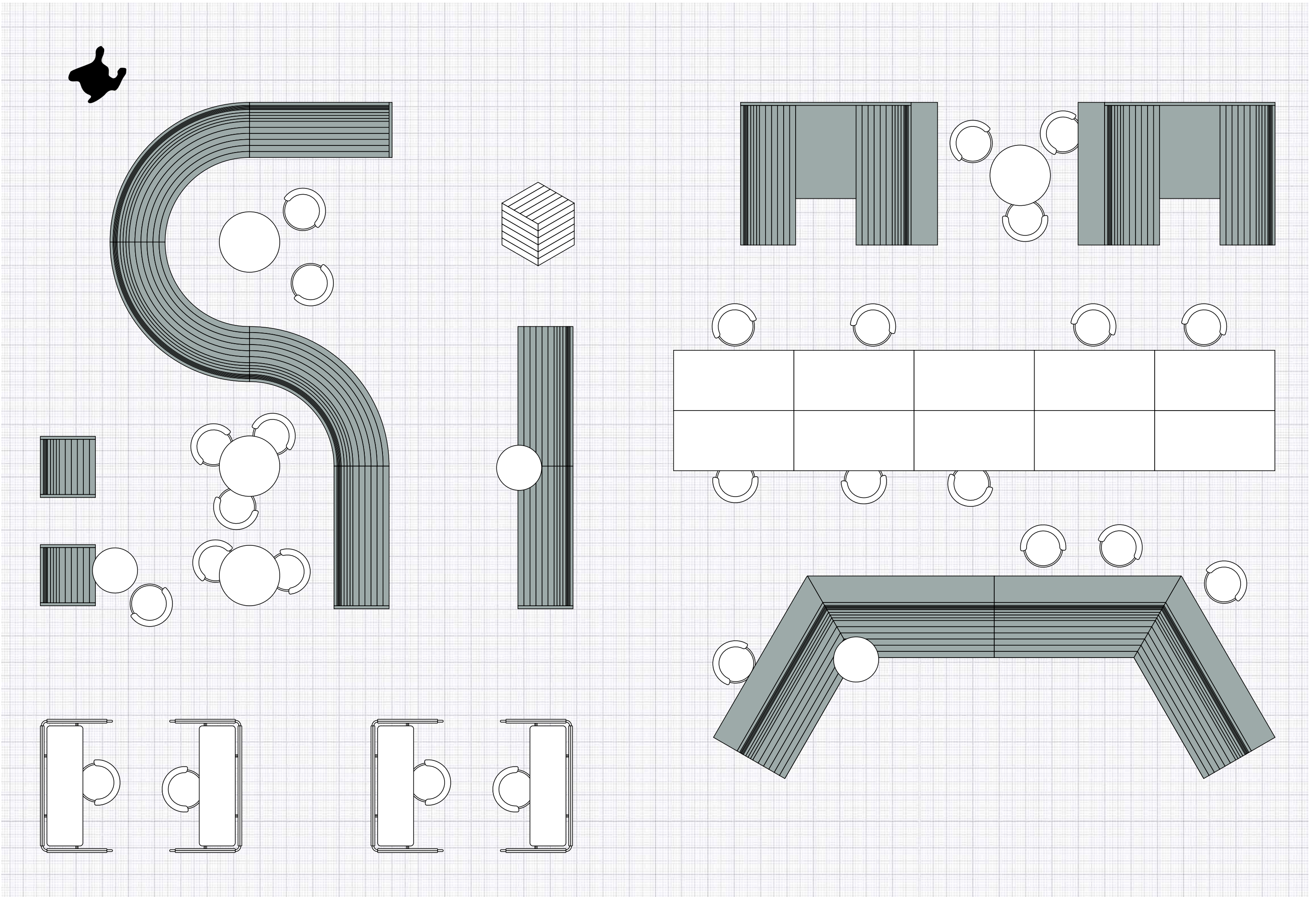









STRIPES sofa
9SS305 cm 145x73x133h
Fabric: cat. B art. Camira Xtreme Plus col. Panama YS079
Metal base: OPM1 shiny chrome metal



STRIPES customized sofa
cm 900x73x133h
Leather: cat. Super art. Dollaro col. 7290
Metal base: RAL 9006 white aluminium painted





STRIPES sofa
9SS208 cm 185x73x133h
 Fabric:
 External side: cat. E art. Camira Blazer II col. Silverdale CUZ28
 Seat: cat. B art. Camira Xtreme Plus col. Diablo YS101
 Backrest: cat. B art. Camira Xtreme Plus col. Panama YS079
 Metal base: OPM1 shiny chrome metal

STRIPES composition A**9SS614 cm 225/185x73x101h**

Fabric: cat. B art. Gabriel Atlantic col. 64116

Metal base: OPM6 RAL 9017 traffic black painted

9SS809 low shelves

HPL colour 1661

Metal base: OPM6 RAL 9017 traffic black painted

Cushions

9RL112 cm 63x33

Fabric: cat. B art. Gabriel Atlantic col. 62048

9SS805 Belux lamps**9SS802** Schulte Evoline sockets**9SS801** Mobile socket**PIVOT** swivel chair**9PIV101 cm 55.5x54x80h**

Fabric: cat. B art. Gabriel Atlantic col. 64116 red and 62048 green

Oak structure in natural oak OPR4

PIVOT table**7PIV101 ø cm 60x43/61h**

OPR4 natural oak

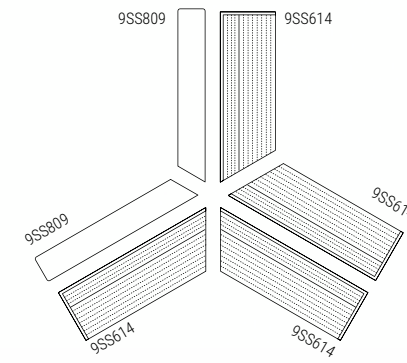



STRIPES composition A
9SS614 cm 225/185x73x101h
 Fabric: cat. B art. Gabriel Atlantic col. 64116
 Metal base: OPM6 RAL 9017 traffic black painted
9SS809 low shelves
 HPL colour 1661
 Metal base: OPM6 RAL 9017 traffic black painted

Cushions
9RL112 cm 63x33
 Fabric: cat. B art. Gabriel Atlantic col. 62048

9SS805 Belux lamps
9SS802 Schulte Evoline sockets
9SS801 Mobile socket

PIVOT swivel chair
9PIV101 cm 55.5x54x80h
 Fabric: cat. B art. Gabriel Atlantic
 col. 64116 red and 62048 green
 Oak structure in natural oak OPR4

PIVOT table
7PIV101 ø cm 60x43/61h
 OPR4 natural oak

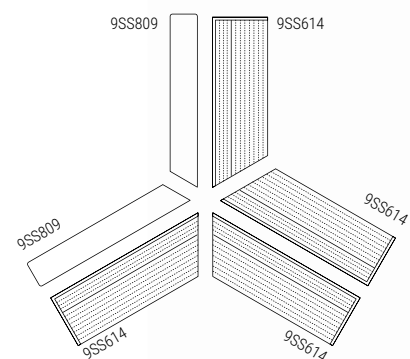

STRIPES curved composition B ø cm 370
9SS908 cm 73x133h
9SS907 cm 73x133h
 Fabric: cat. B art. Gabriel Atlantic col. 64116
 Metal base: OPM6 RAL 9017 traffic black painted

Cushions
9RL112 cm 63x33
 Fabric: cat. B art. Gabriel Atlantic col. 64116 and 61163

PIVOT table
7PIV101 ø cm 60x43/61h
 OPR4 natural oak

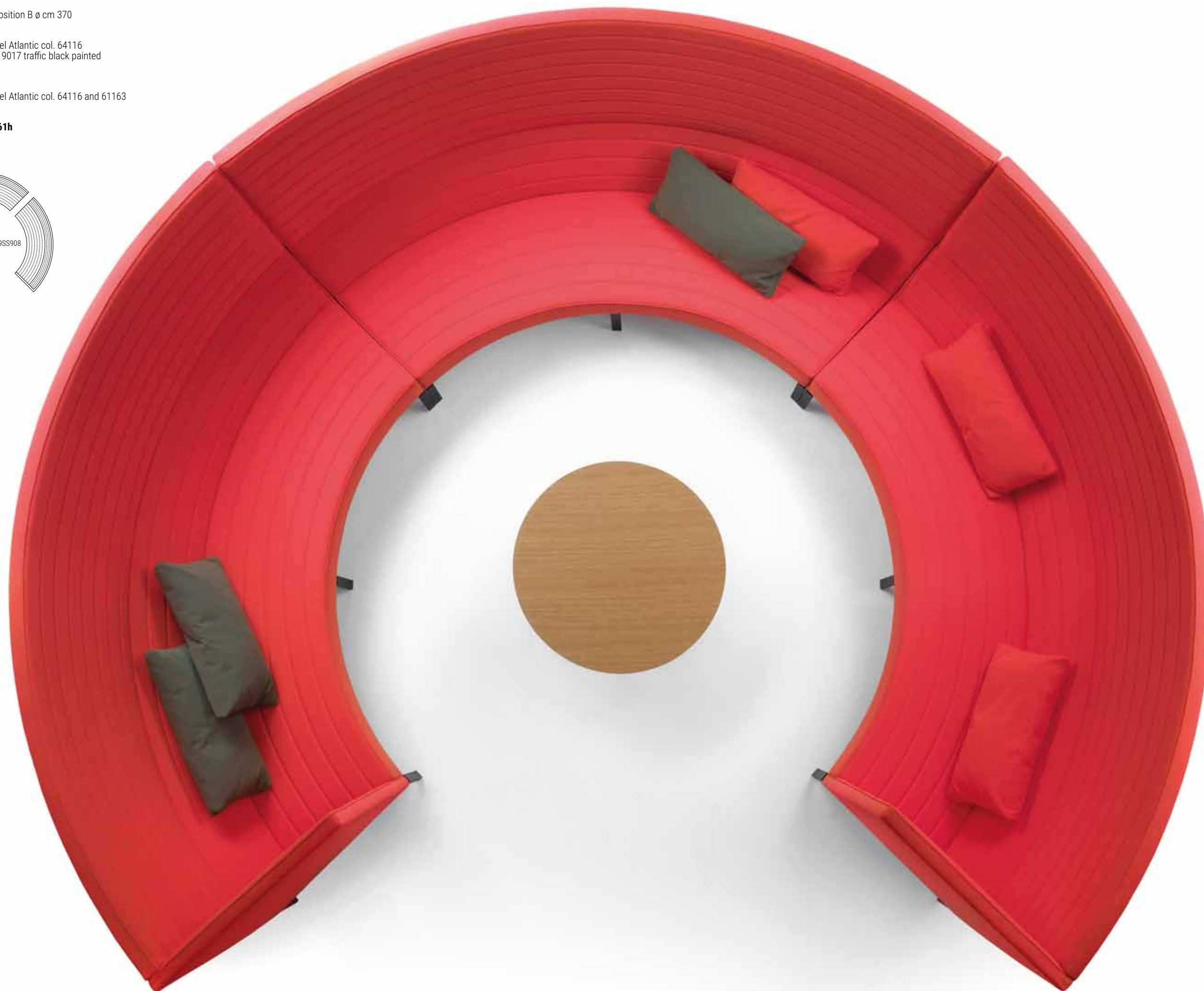
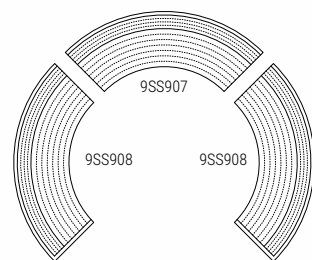

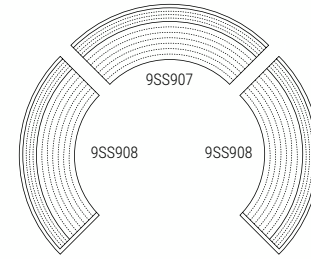

STRIPES curved composition B ø cm 370
9SS908 cm 73x133h
9SS907 cm 73x133h
 Fabric: cat. B art. Gabriel Atlantic col. 64116
 Metal base: OPM6 RAL 9017 traffic black painted

Cushions
9RL112 cm 63x33
 Fabric: cat. B art. Gabriel Atlantic col. 64116 and 61163

PIVOT table
7PIV101 ø cm 60x43/61h
 OPR4 natural oak





STRIPES composition C
9SS208 cm 185x73x133h
 Fabric: cat. B art. Gabriel Atlantic col. 61163
 Metal base: OPM6 RAL 9017 traffic black painted
9SS404X table cm 82x133x133h
9SS808 high shelf
 HPL colour 1661

Cushions
9RL112 cm 63x66
 Fabric: cat. B art. Gabriel Atlantic col. 66086

9SS803 Bachmann Power Frame electric module
9SS804 Mobile lamp
9SS805 Belux lamp
9SS802 Schulte Evoline socket

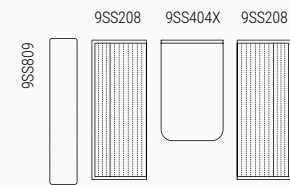
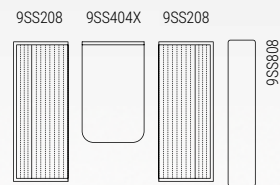

STRIPES composition C
9SS208 cm 185x73x133h
 Fabric: cat. B art. Gabriel Atlantic col. 61078
 Metal base: OPM6 RAL 9017 traffic black painted
9SS404X table cm 82x133x133h
9SS809 low shelf
 HPL colour 1661

Cushions
9RL112 cm 63x66
 Fabric: cat. B art. Gabriel Atlantic col. 66086

9SS803 Bachmann Power Frame electric module
9SS804 Mobile lamp
9SS805 Belux lamp
9SS802 Schulte Evoline socket

PIVOT swivel chair
9PIV101 cm 55.5x54x80h
 Fabric: cat. B art. Gabriel Atlantic col. 66086
 Oak structure in natural oak OPR4

STRIPES composition C
9SS208 cm 185x73x133h
 Fabric: cat. B art. Gabriel Atlantic col. 61078
 Metal base: OPM6 RAL 9017 traffic black painted
9SS809 low shelf
9SS404X table **cm 82x133x133h**
 HPL colour 1661

Cushions
9RL112 cm 63x66
 Fabric: cat. B art. Gabriel Atlantic col. 66086

9SS803 Bachmann Power Frame electric module
9SS804 Mobile lamp
9SS805 Belux lamp
9SS802 Schulte Evoline socket

PIVOT swivel chair
9PIV101 cm 55.5x54x80h
 Fabric: cat. B art. Gabriel Atlantic col. 66086
 Oak structure in natural oak OPR4

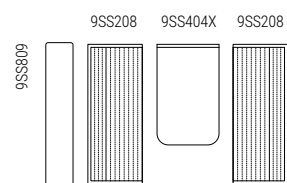

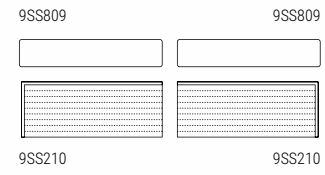

STRIPES composition D
9SS210 cm 185x73x101h
 Fabric: cat. B art. Gabriel Atlantic col. 61078
 Metal base: OPM6 RAL 9017 traffic black painted
9SS809 low shelves
 HPL colour 1661

9SS806 Mobile shelf
9SS805 Belux lamps
9SS801 Mobile socket

PIVOT swivel chair
9PIV101 cm 55.5x54x80h
 Fabric: cat. B art. Gabriel Atlantic
 col. 64116 red and 60063 beige
 Oak structure in natural oak OPR4

PIVOT table
7PIV101 ø cm 60x43/61h
 OPR4 natural oak



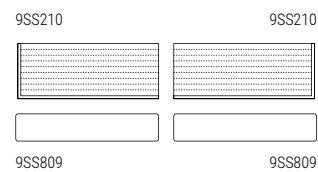

STRIPES composition D
9SS210 cm 185x73x101h
 Fabric: cat. B art. Gabriel Atlantic col. 61078
 Metal base: OPM6 RAL 9017 traffic black painted
9SS809 low shelf
 HPL colour 1661

9SS806 Mobile shelf
9SS805 Belux lamps
9SS801 Mobile socket

PIVOT swivel chair
9PIV101 cm 55.5x54x80h
 Fabric: cat. B art. Gabriel Atlantic
 col. 64116 red, 60063 beige and 61163 brown
 Oak structure in natural oak OPR4

PIVOT table
7PIV101 ø cm 60x43/61h
 OPR4 natural oak

PIVOT table
7PIV102 ø cm 78x43/74h
 OPR4 natural oak



STRIPES composition E
9SS401 cm 73x73x133h
 Fabric: cat. B art. Gabriel Atlantic col. 60063 beige
 Metal base: OPM6 RAL 9017 traffic black painted
9SS405X table cm 82x55x133h
 HPL colour 1661

STRIPES composition F
9SS610 cm 255x73x133h
 Fabric: cat. B art. Gabriel Atlantic col. 60063 beige
 Metal base: OPM6 RAL 9017 traffic black painted
9SS808 high shelf cm 36x104
 HPL colour 1661

Cushions **9RL112 cm 63x33**
 Fabric: cat. B art. Gabriel Atlantic col. 61163

9SS805 Belux lamp

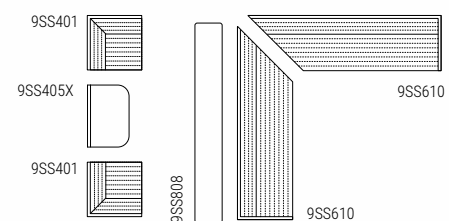

PIVOT swivel armchairs
9PIV101 cm 55.5x54x80h
 Fabric: cat. B art. Atlantic col. 60063 and 61163

PIVOT tables
7PIV101 ø cm 60x43/61
7PIV102 ø cm 78x43/74h
 OPR4 natural oak





STRIPES sofa with roof
9SS924 cm 185x73x183h
Fabric: cat. B Gabriel Atlantic col. 60063 beige
Metal base: OPM6 RAL 9017 traffic black painted

PIVOT table
7PIV101 ø cm 60x43/61h
OPR4 natural oak

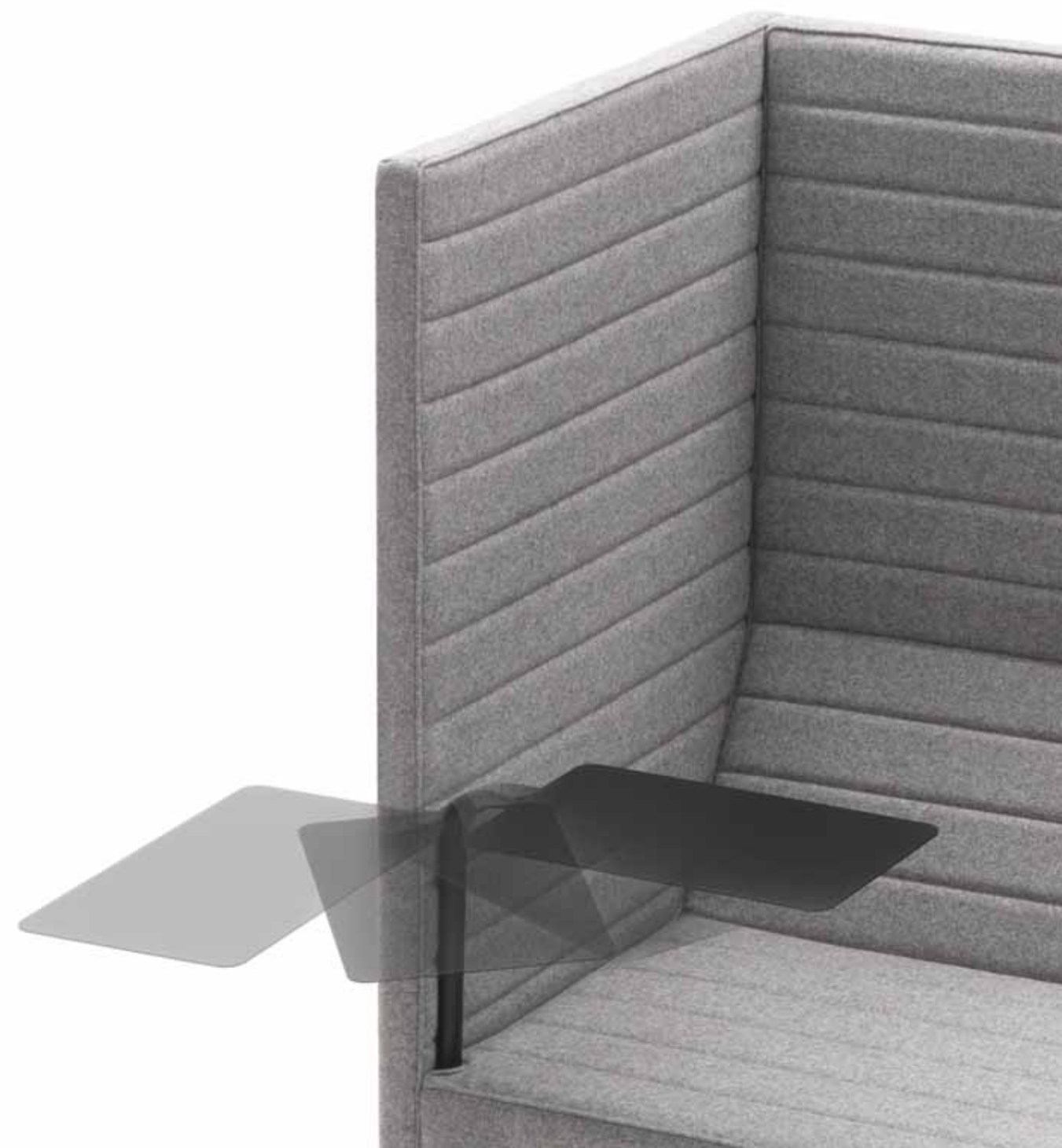

**STRIPES** sofa**9SS305 cm 145x73x133h**Fabric: cat. E art. Camira Blazer col. Surrey CUZ1E
Metal base: OPM6 RAL 9017 traffic black painted**9SS807** Bachmann Power Frame electric module**9SS810** RAL 9017 traffic black painted mobile writing shelf



STRIPES composition G
9SS401 cm 73x73x133h
 Fabric: cat. E art. Camira Blazer col. Silcoates CUZ30
 Metal base: RAL 9006 white aluminium painted
9SS403X table cm 73x41x133h
 White melamine

9SS803 Bachmann Power Frame electric module

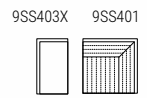

STRIPES composition H
9SS401 cm 73x73x133h
 Fabric: cat. E Camira Blazer col. Surrey CUZ1E
 Metal base: RAL 9006 white aluminium painted
9SS402X table cm 82x55x133h
 White melamine

9SS803 Bachmann Power Frame electric module

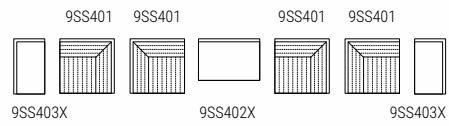
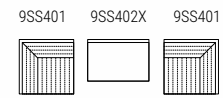

Stripes composition made of 2 compositions "G" and 1 composition "H", as described above.



STRIPES sofa without arms
9SS201 cm 145x73x101h with vertical quilting
9SS101 bench cm 145x73x42,5h with vertical quilting
 Fabric: cat. E art. Camira Blazer col. Edinburgh CUZ1Y
 Metal base: OPM6 RAL 9017 traffic black painted

STRIPES
9SS202 cm 145x73x101h sofa with 1 arm
9SS101 bench cm 145x73x42,5h with vertical quilting
9SS101 bench cm 145x73x42,5h
 Fabric: cat. E art. Camira blazer col. Bryanstom CUZ53
 Metal base: OPM6 RAL 9017 traffic black painted



Stripes is available with horizontal and, on demand, with vertical quilting.





STRIPES sofas without arms
9SS201 cm 145x73x101h with vertical quilting
9SS101 bench cm 145x73x42.5h with vertical quilting
 Fabric: cat. E art. Camira Blazer col. Edinburgh CUZ1Y
 Metal base: OPM6 RAL 9017 traffic black painted

STRIPES sofas with 1 arm
9SS202 cm 145x73x101h
 Fabric: cat. E art. Camira blazer col. Bryanstom CUZ53
 Metal base: OPM6 RAL 9017 traffic black painted





STRIPES sofa
9SS204 cm 145x73x86h
 Fabric: cat. E art. Camira blazer col. Bryanstom CUZ53
 Metal base: RAL 9006 white aluminium painted

PIVOT swivel chair
9PIV101 cm 55.5x54x80h
 Fabric: cat. E art. Camira Blazer col. Silverdale CUZ28
 Oak structure in natural oak OPR4

PIVOT table
7PIV101 ø cm 60x43/61h
 OPR4 natural oak





STRIPES composition J
9SS614 cm 225x73x101h with an angle of 60°
9SS627 cm 265x73x101h with an angle of 60°
 Fabric: cat. E art. Camira Blazer col. Surrey CUZ1E
 Metal base: OPM6 RAL 9017 traffic black painted
9SS809 low shelves
 HPL colour 1661

PIVOT swivel chair
9PIV101 cm 55.5x54x80h
 Fabric: cat. E art. Camira Blazer col. Surrey CUZ1E
 Oak structure in natural oak OPR4

PIVOT table
7PIV101 ø cm 60x43/61h
 OPR4 natural oak

PIVOT table
7PIV102 ø cm 78x43/74h
 OPR4 natural oak

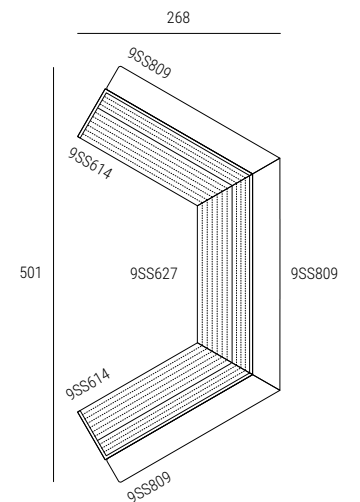

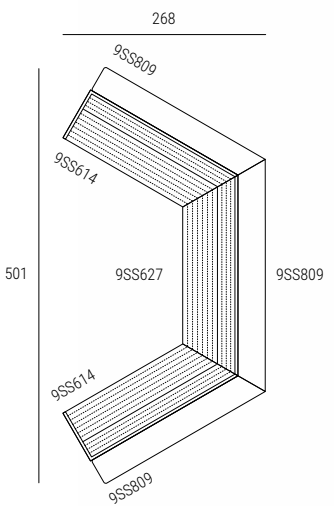

STRIPES composition J
9SS614 cm 225x73x101h with an angle of 60°
9SS627 cm 265x73x101h with an angle of 60°
 Fabric: cat. E art. Camira Blazer col. Surrey CUZ1E
 Metal base: OPM6 RAL 9017 traffic black painted
9SS809 low shelves
 HPL colour 1661

PIVOT swivel chair
9PIV101 cm 55.5x54x80h
 Fabric: cat. E art. Camira Blazer col. Surrey CUZ1E
 Oak structure in natural oak OPR4

PIVOT table
7PIV101 ø cm 60x43/61h
 OPR4 natural oak

PIVOT table
7PIV102 ø cm 78x43/74h
 OPR4 natural oak

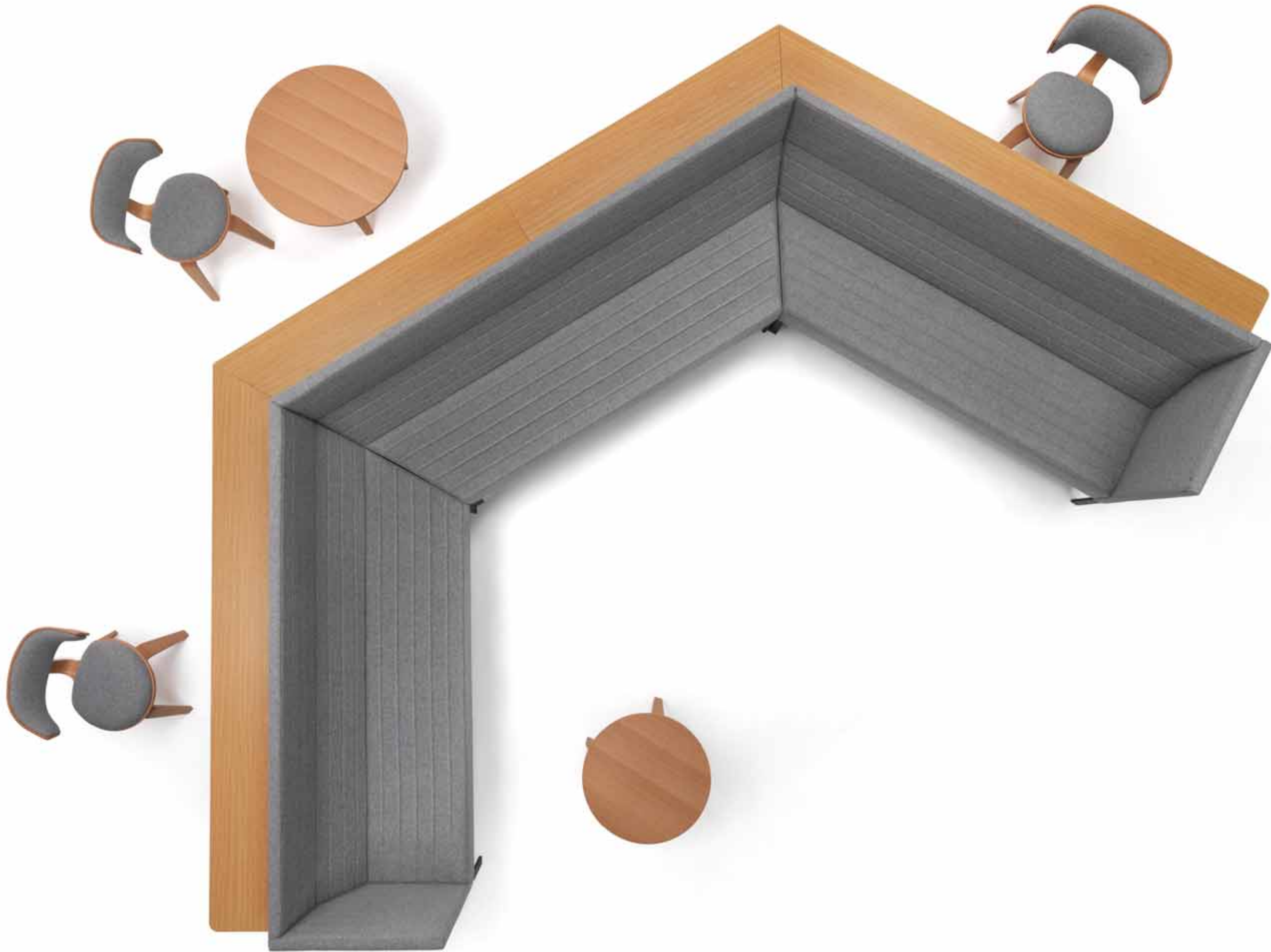

STRIPES composition M cm 161x552
9SS925 cm 73x42,5h
 Fabric: cat. B art. Gabriel Atlantic col. 60011 grey
 Metal base: OPM6 RAL 9017 traffic black painted

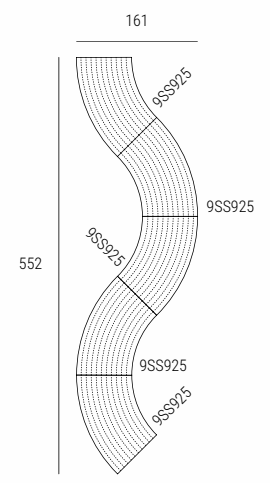



STRIPES composition cm 370x370
9SS925 cm 73x42,5h
9SS505 cm 73x101h
 Fabric: cat. B art. Gabriel Atlantic col. 60011 grey and 68054 green
 Metal base: OPM6 RAL 9017 traffic black painted

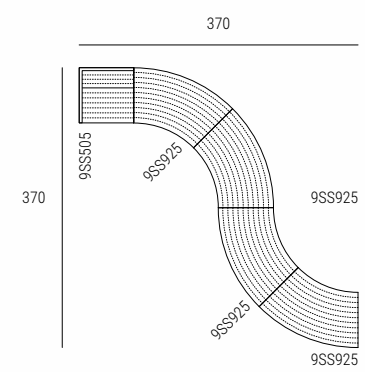

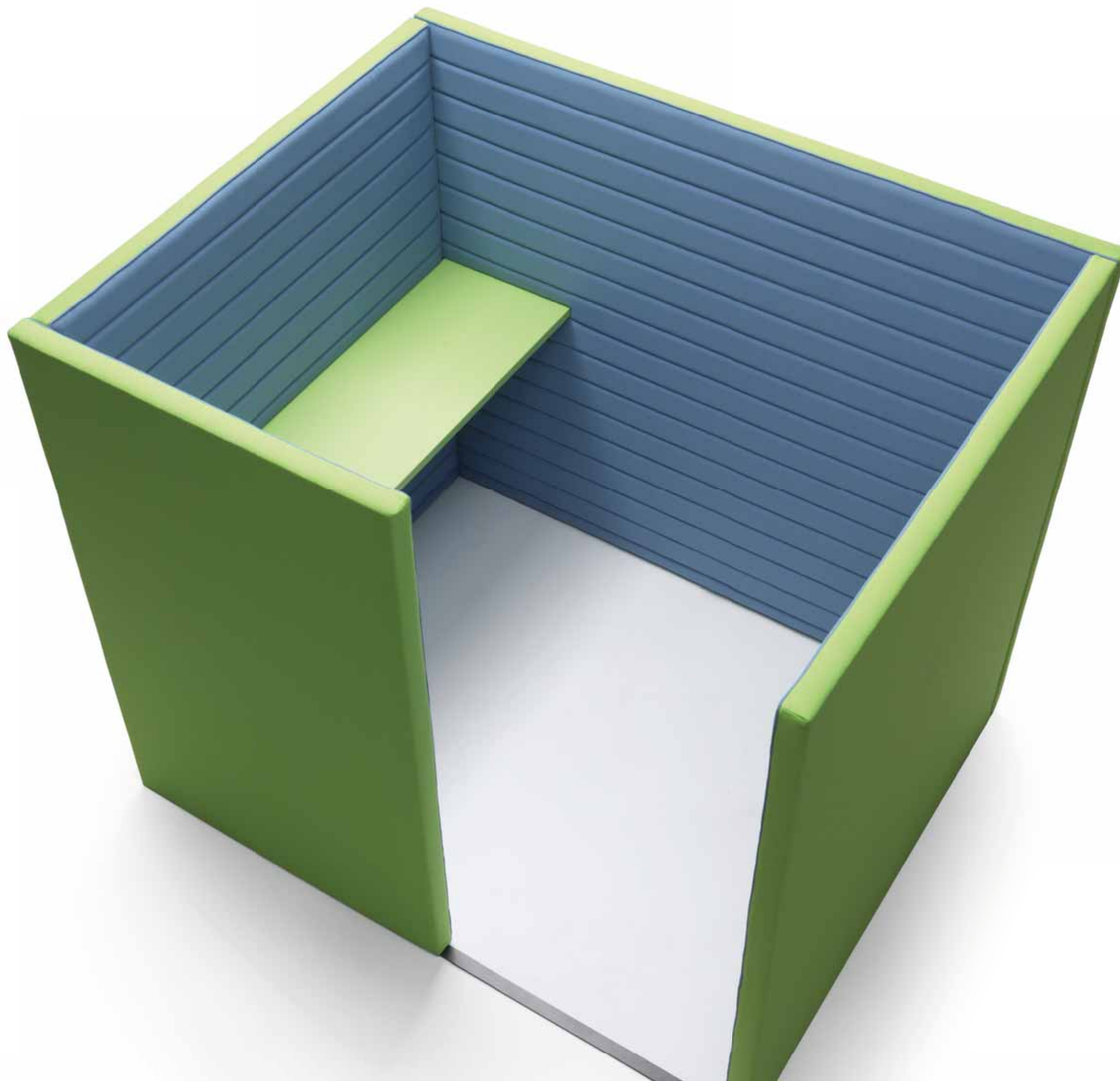

STRIPES composition
95912 cm 125x156x133h
Fabric: External side: cat. B art. Camira Xtreme Plus col. YS156 Madura
Internal quilted side: cat. B art. Camira Xtreme Plus col. YS095 Steel
Table top: Fundermax HPL, apple green

STRIPES**9SS913 cm 100x73x215h**

Fabric: External side: cat. B art. Camira Xtreme Plus col. YS156 Madura
Internal quilted side: cat. B art. Camira Xtreme Plus col. YS095 Steel
Table top: Fundermax HPL, apple green

9SS803 Bachmann Power Frame electric module



9SS208 9SS401X 9SS208

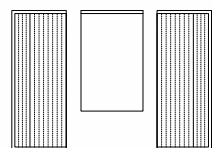

>

STRIPES composition L
9SS208 cm 185x73x133h

Fabric:

External side:

cat. B art. Camira Xtreme Plus col. YS156 Madura

Internal quilted side:

cat. B art. Camira Xtreme Plus col. YS095 Steel

Metal base:

OPM6 RAL 9017 traffic black painted metal

9SS401X table **cm 82x133x133h**

Fundermax HPL, apple green

9SS803 Bachmann Power Frame electric module

STRIPES**9SS914 cm 185x73x133h (x2)**

Fabric: External side: cat. B art. Camira Xtreme Plus col. YS156 Madura
Internal quilted side: cat. B art. Camira Xtreme Plus col. YS095 Steel

9SS915 cm 228x185x133h

Fabric: External side: cat. B art. Camira Xtreme Plus col. YS156 Madura
Internal quilted side: cat. B art. Camira Xtreme Plus col. YS095 Steel

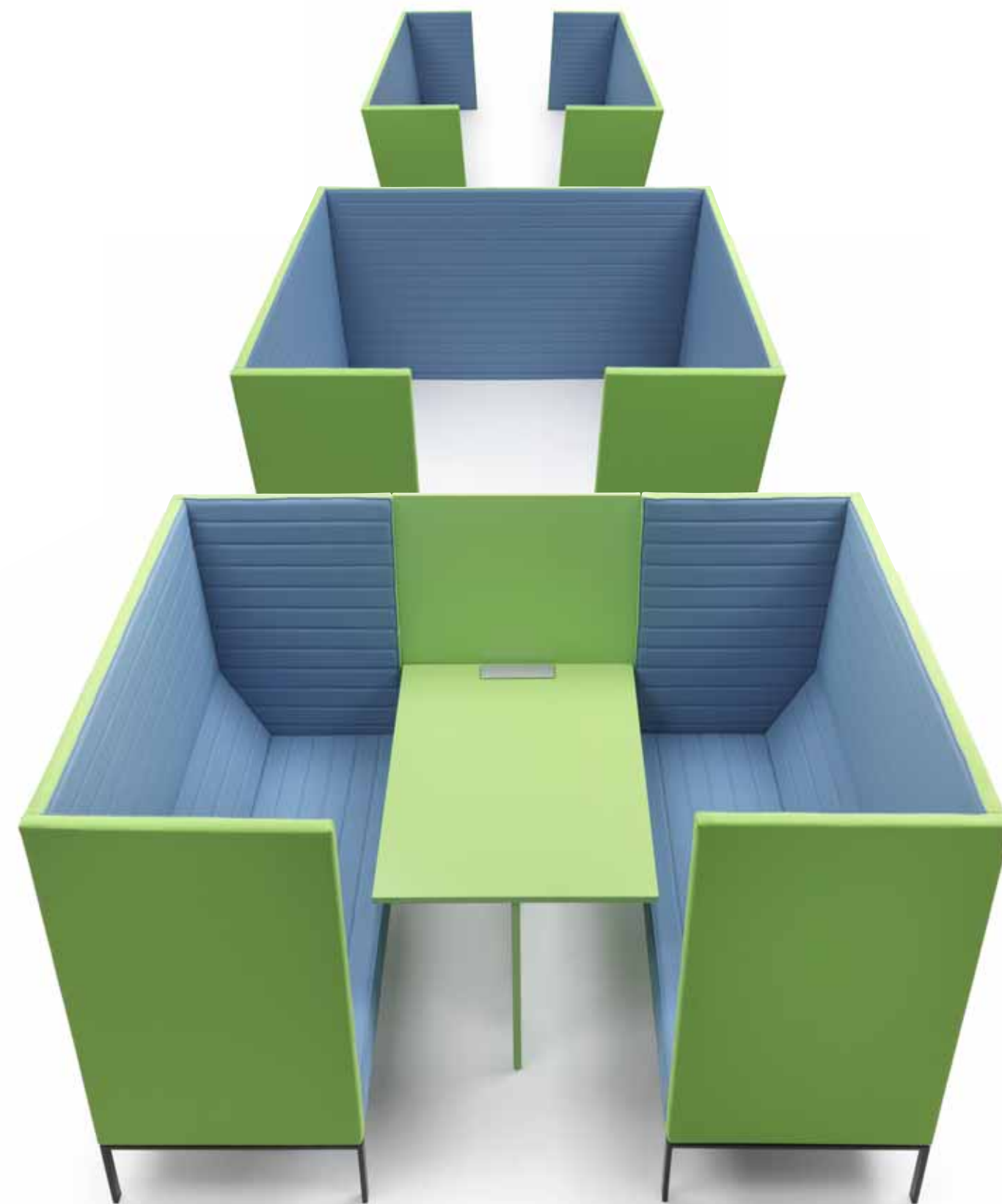

STRIPES box with led lighting
955916 cm 228x185x223h
Fabric: cat. B Camira Xtreme Plus col. Tonga YS160
Metal base: OPM7 RAL 9016 white painted metal
Table: white HPL

955803 Bachmann Power Frame electric module

Cable channel available on demand





Detail of STRIPES box with led lighting
9SS916 cm 228x185x223h



STRIPES box
9SS917 cm **228x185x133h**
 Fabric: cat. B Camira Xtreme Plus col. Tonga YS160
 Metal base: OPM7 RAL 9016 white painted metal
 Table: white HPL

9SS803 Bachmann Power Frame electric module



STRIPES box with led lighting
9SS921 cm 228x73x223h
 Fabric: cat. F art. Camira Oxygen BA056 Flexor
 Metal base: OPM7 RAL 9016 white painted metal
 Table: white HPL
9SS803 Bachmann Power Frame electric module

STRIPES composition K cm 185 x 580

9SS207 cm 185x73x133h

9SS909 cm 73x133h

9SS906 cm 73x133h

9SS907 cm 73x133h

Fabric: cat. H art. Kvadrat Steelcut Trio col. 853
Metal base: OPM6 RAL 9017 traffic black painted
9SS809 low shelf
Birch plywood natural oak veneered

9SS805 Belux lamp

9SS802 Schulte Evoline socket

PIVOT swivel chair

9PIV101 cm 55.5x54x80h

Fabric: cat. B art. Gabriel Atlantic col. 61163
and cat. H art. Kvadrat Steelcut Trio col. 853
Oak structure in natural oak OPR4

PIVOT table

7PIV101 ø cm 60x43/61h

OPR4 natural oak

PIVOT table

7PIV102 ø cm 78x43/74h

OPR4 natural oak

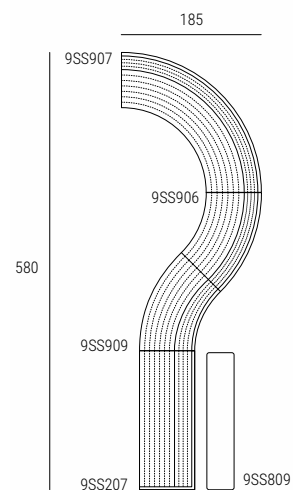

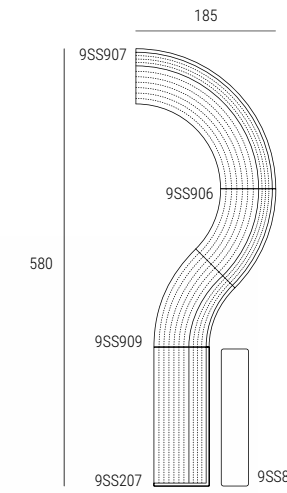

STRIPES composition K cm 185 x 580
9SS207 cm 185x73x133h
9SS909 cm 73x133h
9SS906 cm 73x133h
9SS907 cm 73x133h
 Fabric: cat. H art. Kvadrat Steelcut Trio col. 853
 Metal base: OPM6 RAL 9017 traffic black painted
9SS809 low shelf
 Birch plywood natural oak veneered

9SS805 Belux lamp
9SS802 Schulte Evoline socket

PIVOT swivel chair
9PIV101 cm 55.5x54x80h
 Fabric: cat. B art. Gabriel Atlantic col. 61163
 and cat. H art. Kvadrat Steelcut Trio col. 853
 Oak structure in natural oak OPR4

PIVOT table
7PIV101 ø cm 60x43/61h
 OPR4 natural oak

PIVOT table
7PIV102 ø cm 78x43/74h
 OPR4 natural oak



STRIPES box
9SS920 cm 228x145x133h
Fabric: cat. D art. Camira Main Line Flax col. 29
Table: OPR4 natural oak
9SS803 Bachmann Power Frame electric module



STRIPES sofas with castors
9SS208 cm 185x73x133h
Fabric: cat. B art. Gabriel Atlantic col. 67030
Metal base: OPM6 RAL 9017 traffic black painted with castors 9SS811
9SS102 server cm 60x30x62h

9SS804 Mobile lamp
9SS801 Bachmann Power Frame mobile electric module





STRIPES round composition
9SS907 cm 73x133 (x2)
9SS808 cm 73x133 (x2)
 Fabric: cat. B art. Gabriel Atlantic col. 67030
 Metal base: OPM7 RAL 9016 traffic white painted

9SS808 high shelves
 HPL colour 1661

CHIA swivel armchairs
9CHI103A cm 58x53x77h
 Fabric: cat. B art. Gabriel Atlantic col. 67030
 Metal base A: OPM6 RAL 9017 traffic black painted



STRIPES armchairs
9SS107 cm 80x73x133h
 Fabric: cat. B art. Camira Xtreme Plus col. Havana YS009
 Metal base: OPM1 shiny chrome



> **STRIPES** swivel armchair
9SS108 cm 80x73x133h
 Fabric: cat. B art. Camira Xtreme Plus
 col. Havana YS009
 Swivel metal base: OPM1 shiny chrome



STRIPES

DESIGN JÉRÔME GAUTHIER
2009

Available widths

Available heights

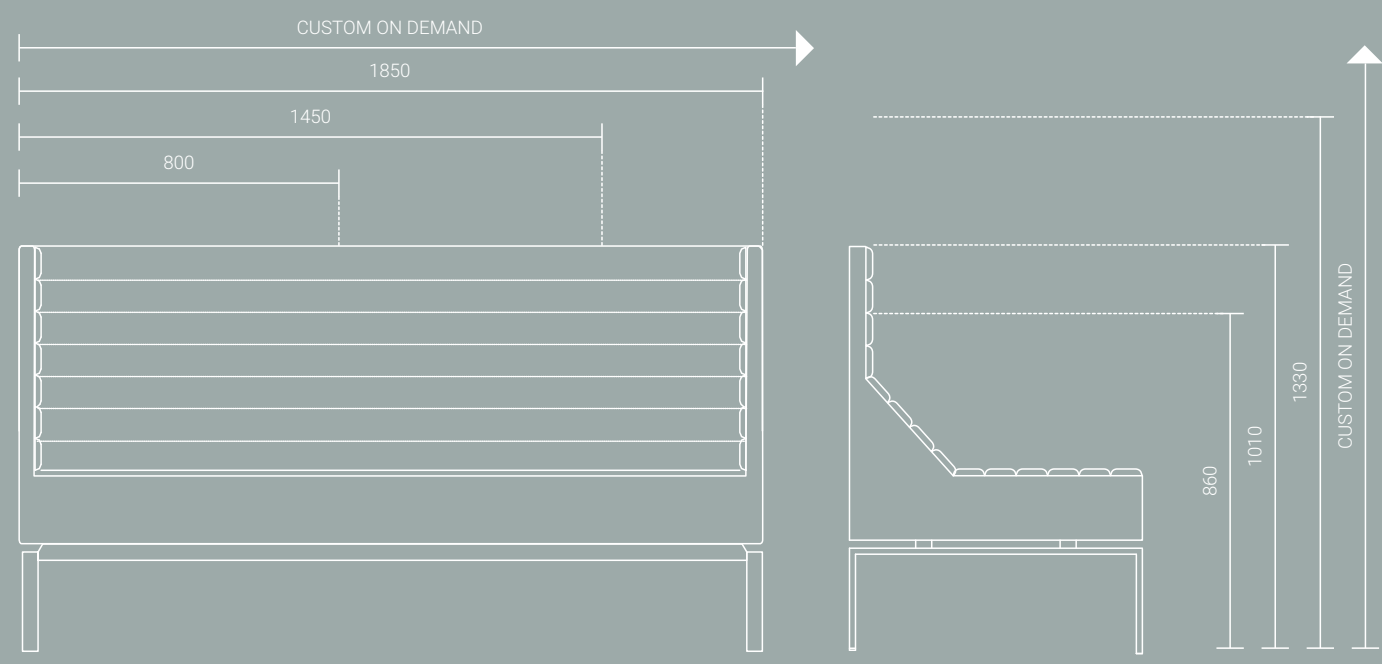

Accessories



9RL112
L63 H33
Feather cushion
without band



9SS101
L145 P73 H42,5

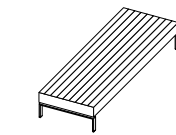

9SS103
L185 P73 H42,5

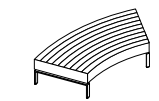

9SS925
P73 H42,5
Round bench element



9SS102
L60 P30 H62
Horizontally adjustable
server with metal top

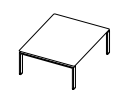

9SS104
L73 P73 H37
Small table with
transparent glass top

STRIPES

DESIGN JÉRÔME GAUTHIER
2009

H101

Sofas



9SS112
L80 P73 H101

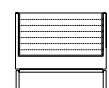

9SS114
L120 P73 H101



9SS113
L80 P73 H101
Swivel armchair



9SS505
L73 P73 H101
Corner element

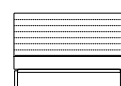

9SS201
L145 P73 H101



9SS202
L145 P73 H101

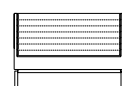

9SS204
L145 P73 H101



9SS209
L185 P73 H101

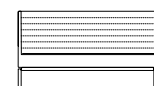

9SS210
L185 P73 H101

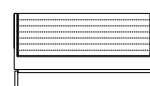

9SS212
L185 P73 H101

H133

Sofas



9SS107
L80 P73 H133

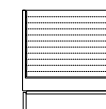

9SS304
L120 P73 H133



9SS108
L80 P73 H133
Swivel armchair



9SS401
L73 P73 H133
Corner element



9SS301
L145 P73 H133

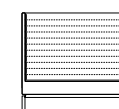

9SS303
L145 P73 H133

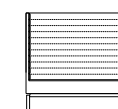

9SS305
L145 P73 H133

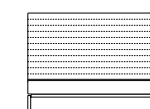

9SS205
L185 P73 H133

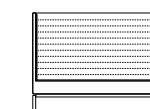

9SS207
L185 P73 H133

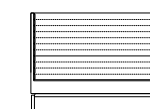

9SS208
L185 P73 H133

STRIPES

DESIGN JÉRÔME GAUTHIER
2009

H101

Sofas

With an angle of 60°

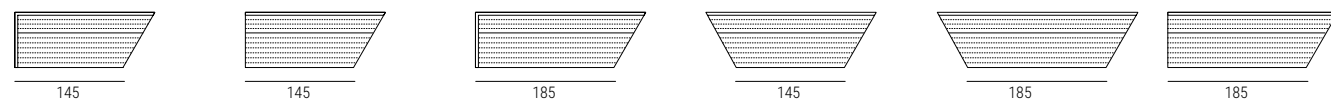

145

145

185

145

185

185

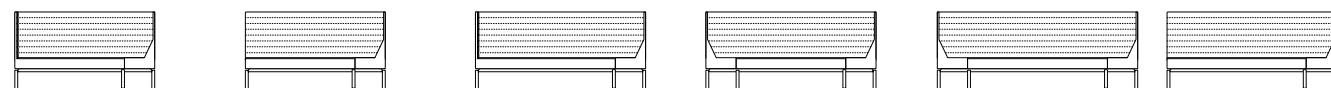

9SS612
L185 P73 H101

9SS613
L185 P73 H101

9SS614
L225 P73 H101

9SS615
L225 P73 H101

9SS627
L265 P73 H101

9SS616
L225 P73 H101

With an angle of 45°

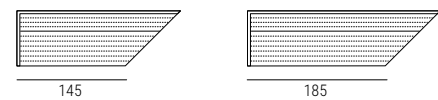

145

185

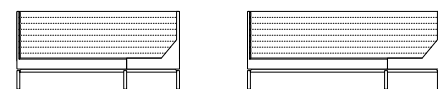

9SS600
L215 P73 H101

9SS602
L255 P73 H101

H133

Sofas

With an angle of 60°

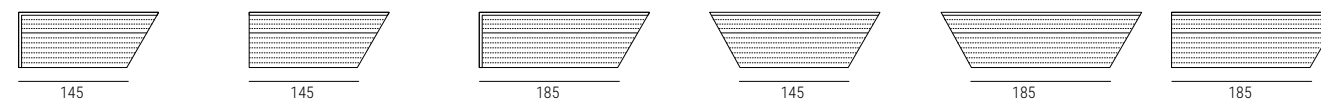

145

145

185

145

185

185

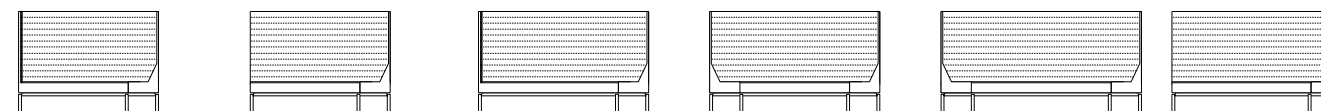

9SS620
L185 P73 H133

9SS624
L185 P73 H133

9SS622
L225 P73 H133

9SS625
L225 P73 H133

9SS628
L265 P73 H133

9SS626
L225 P73 H133

With an angle of 45°

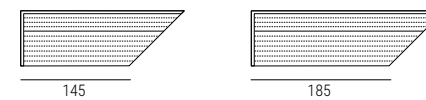

145

185

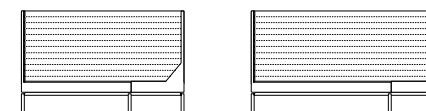

9SS608
L215 P73 H133

9SS610
L255 P73 H133

STRIPES

DESIGN JÉRÔME GAUTHIER
2009

H101

H133

Round elements

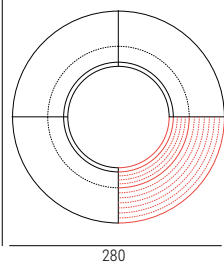
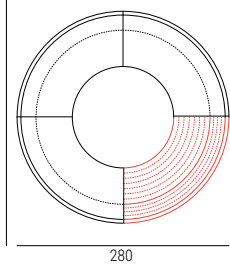
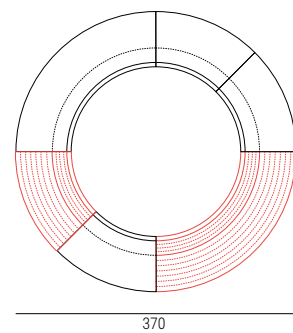
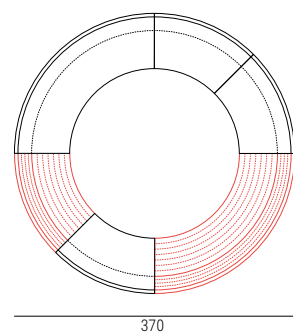
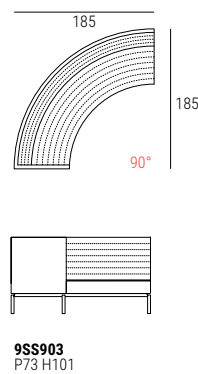
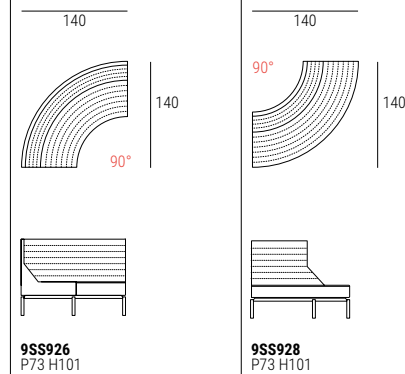
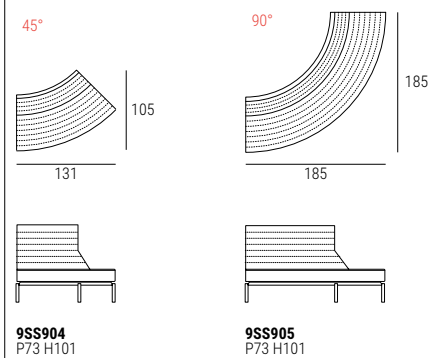
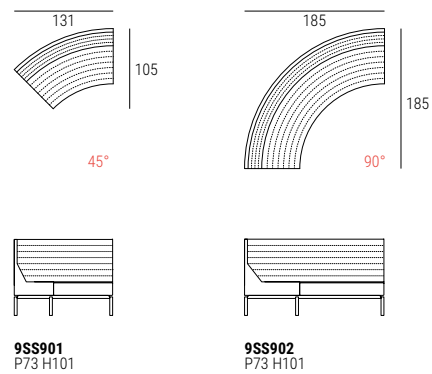

Round elements

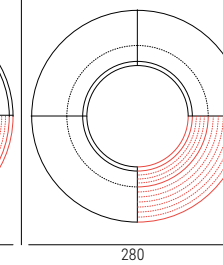
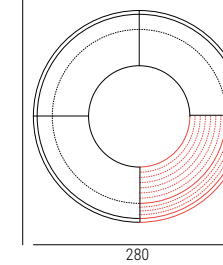
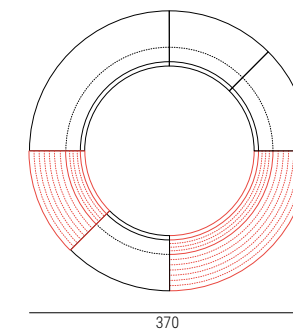
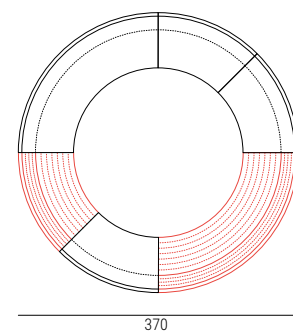
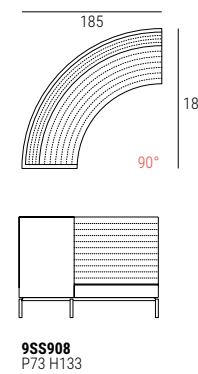
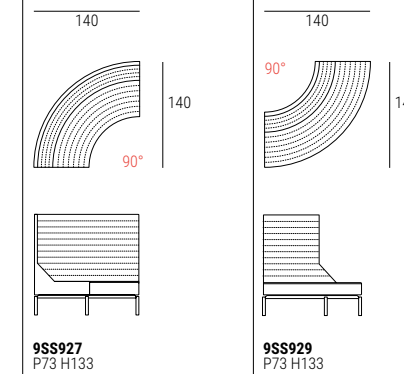
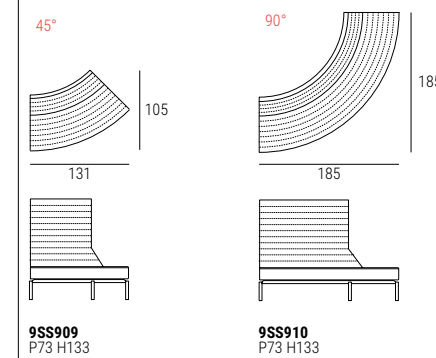
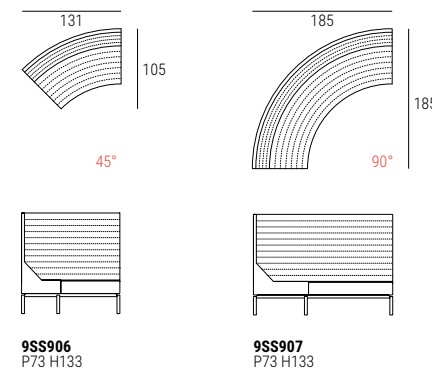

STRIPES

DESIGN JÉRÔME GAUTHIER
2009

H133

Tables
25 mm thick

Tables

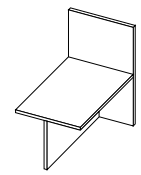

9SS401X
L82 P133 H133
Table

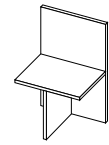

9SS402X
L82 P55 H133
Table

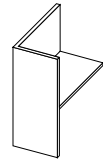

9SS403X
L73 P41 H133
Table

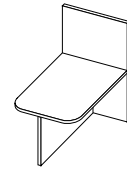

9SS404X
L82 P133 H133
Table

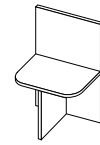

9SS405X
L82 P55 H133
Table

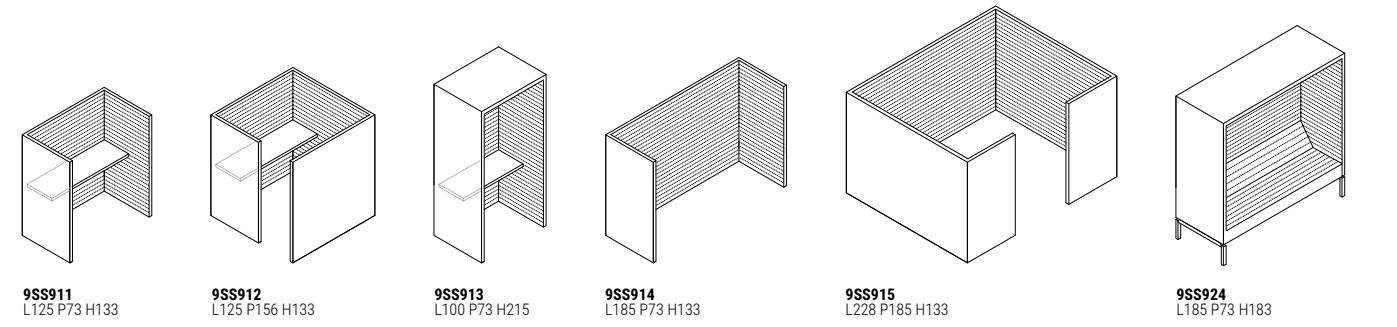

9SS911
L125 P73 H133

9SS912
L125 P156 H133

9SS913
L100 P73 H215

9SS914
L185 P73 H133

9SS915
L228 P185 H133

9SS924
L185 P73 H183

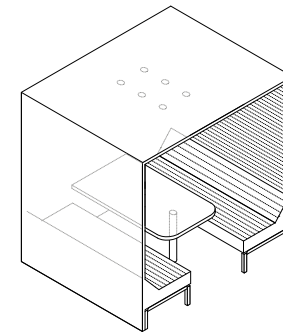

9SS916*
L228 P185 H223
Table size L82 P133

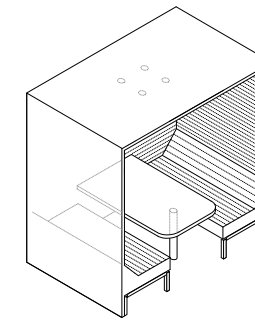

9SS923*
L228 P145 H223
Table size L82 P133

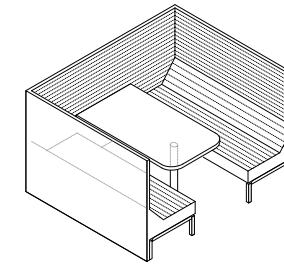

9SS917
L228 P185 H133
Table size L82 P133

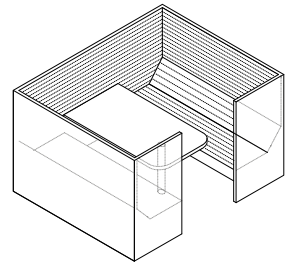

9SS918
L228 P185 H133
Table size L82 P133

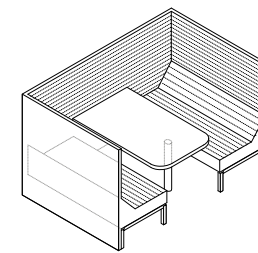

9SS919
L228 P145 H133
Table size L82 P133

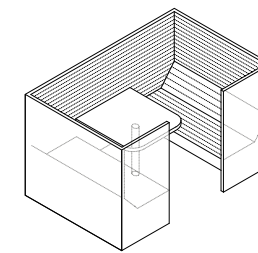

9SS920
L228 P145 H133
Table size L82 P90

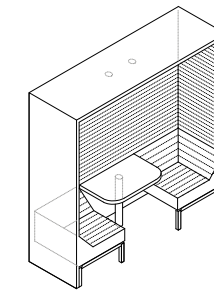

9SS921*
L228 P73 H223
Table size L82 P55

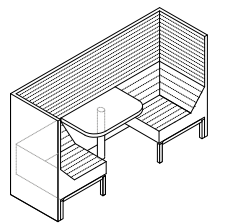

9SS922
L228 P73 H133
Table size L82 P55



*
Activation of led lighting through motion detector (standard version) or, on demand, by means of a switch.

Box

STRIPES

DESIGN JÉRÔME GAUTHIER
2009

Optionals



9SS801 *
L11 P5 H31
Bachmann power frame mobile module



9SS802 **
L10 H10
Schulte Evoline



9SS803 *
L26 x H9
Bachmann power frame module



9SS804
L27 P16 H7,5 (totaleH24)
Mobile lamp



9SS805
ø14 H32
Beluxe lamp



9SS806
L42 P20 H24
Mobile shelf

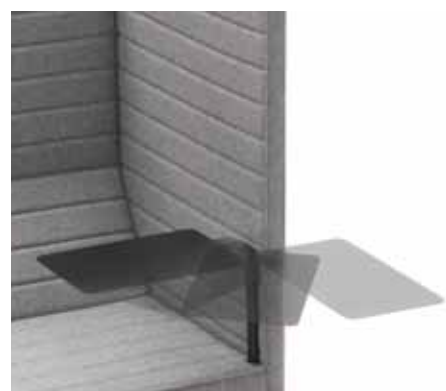

9SS810
L25 P40
Mobile writing shelf



9SS811
Castors

The Bachmann Power Frame electric module is available in the standard version with 2 Schuko and 2 USB sockets, in accordance with the European standards; on demand, it is also available according to the Swiss or British standards or it can be customized with different combinations of internal modules with a price increase.

The standard kit is available with 1 Schuko, 1 USB and 1 RJ45 socket, exclusively according to the European standards.

Optionals



9SS807 *
L24 x H7,5
Bachmann power frame module



9SS808
P36 H104
High shelf for sofas



9SS809
P36 H74
Low shelf for sofas

Finishes

Standard base finishes

Code RAL 9017 traffic black painted metal OPM6	Code RAL 9016 traffic white painted metal OPM7	Code Classic bronze painted metal OPM9	Code Golden beach painted metal OPM10	Code Gold pearl painted metal OPM11	Code RAL 9006 white aluminium painted metal	Code Anodized Bronze metal OPM18

Optional base finishes

Code Shiny chrome metal OPM1	Code Brushed matt chrome metal OPM2	Code Brushed matt dark grey metal OPM3	Code Brushed copper metal OPM12	Code Brushed antique brass metal OPM13	Code Shiny black chrome metal OPM14	Code Brushed antique gold metal OPM15	Code Shiny brass chrome metal OPM16	Code Bronze metal OPM17	Code Metal painted in RAL Classic colors OPM8

STRIPES

DESIGN JÉRÔME GAUTHIER
2009

Compositions

COMPOSITION A

9SS614 x4
Sofa
9SS809 x2
Low shelf

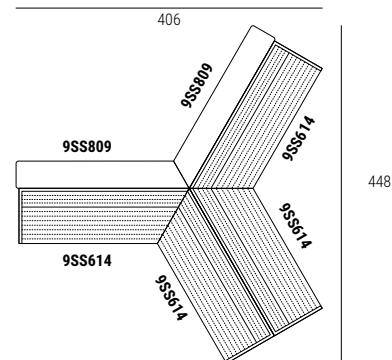

COMPOSITION B

9SS908 x2
Sofa
9SS907
Sofa

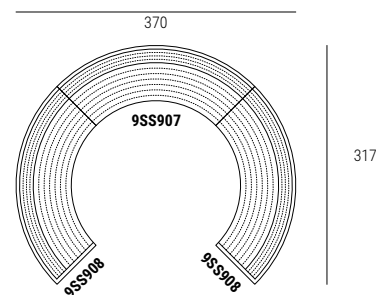

COMPOSITION C with high shelf

9SS208 x2
Sofa
9SS808
High shelf
9SS404X
Table

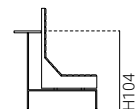
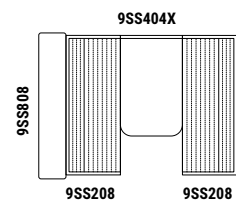

COMPOSITION C with low shelf

9SS208 x2
Sofa
9SS809
Low shelf
9SS404X
Table

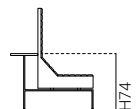
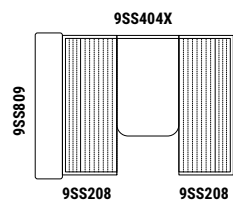

Compositions

COMPOSITION D

9SS210 x2
Sofa
9SS809 x2
Low shelf

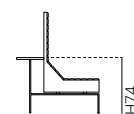
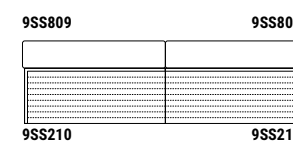

COMPOSITION E

9SS401 x2
Sofa
9SS405X
Table

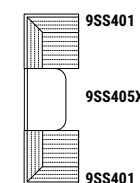

COMPOSITION F

9SS610 x2
Sofa
9SS808
High shelf

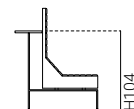
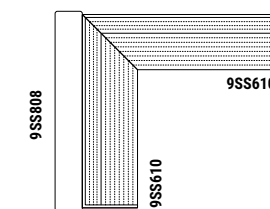

STRIPES

DESIGN JÉRÔME GAUTHIER
2009

Compositions

COMPOSITION G

9SS401
Sofa
9SS403X
Table

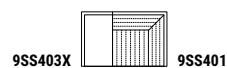

COMPOSITION H

9SS401 x2
Sofa
9SS402X
Table

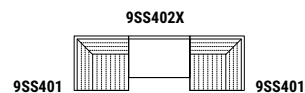

COMPOSITION J

9SS614 x2
Sofa
9SS627 x1
Sofa
9SS809 x3
Low shelf

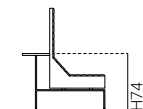
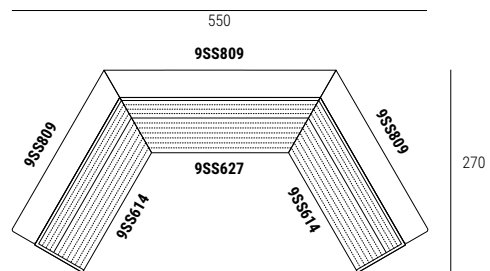

Compositions

COMPOSITION K

9SS907
Sofa
9SS906
Sofa
9SS909
Sofa
9SS207
Sofa
9SS809
Low shelf

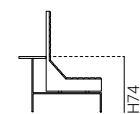
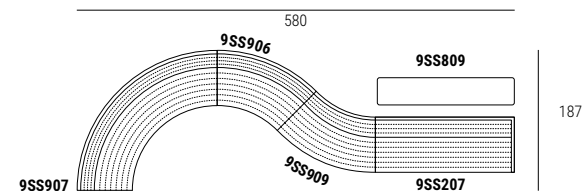

COMPOSITION L

9SS208 x2
Sofa
9SS401X
Table

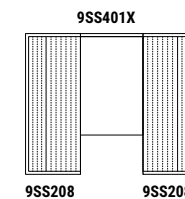

COMPOSITION M

9SS925 x5
Round bench element

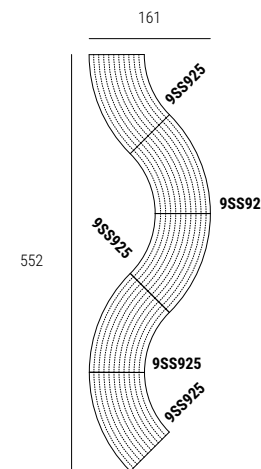

STRIPES

DESIGN JÉRÔME GAUTHIER
2009

La collezione STRIPES, creata dal designer Jérôme Gauthier, è ispirata alle tipiche panchine a doghe in legno orizzontali utilizzate nei parchi pubblici parigini ed è caratterizzata dalla trapuntatura a righe (da cui viene il nome "Stripes").

Stripes è un modello testato fonoadassorbente ed è conforme ai test BIFMA statunitensi.

Per favorire l'ergonomia e la comodità del prodotto, lo schienale è dotato di un poggiaerani con un angolo di inclinazione di ca. 22° in modo tale che non sono necessari cuscinetti per garantire il comfort.

Seduta, schienale e braccioli sono composti da un fusto in pannelli di multistrato da 20 e 40 mm di prima scelta. La resistenza del fusto è garantita da una costruzione ad incastri che offre elevate garanzie di tenuta.

La seduta, priva di cinghie elastiche intrecciate, è in poliuretano espanso CM 40/P kg/m³ 5,9 kPa e rinforzi con SR75 Kg/m³ 15,5 kPa.

Schienale e poggiaerani sono in poliuretano espanso CM 40 kg/m³ 5,9 kPa.

Il fusto e i braccioli sono rivestiti in poliuretano espanso, con una densità di 40 kg/m³ 5,9 kPa e 75 kg/m³ 15,5 kPa.

Per garantire la durabilità del prodotto nel tempo nei punti maggiormente soggetti a deformazione vengono utilizzati degli aggregati di poliuretano espanso della densità complessiva di 200 kg/m³, sotto cui è montata una piastra di metallo da 40 x 5 mm.

La parte esterna del fusto è inoltre rivestita in fibra termolegata di 250 gr.

I braccioli sono fissati tramite bulloni e baionette.

Il poliuretano espanso è sempre ignifugo CMHR (Combustion Modified High Resilient) e risponde alle norme British Standard (BS), Cal 117, Classe 11M, nonché, su richiesta, ad altri standard (per esempio le norme tedesche DIN o le norme francesi NF).

Le caratteristiche righe ("stripes" in inglese), orizzontali o verticali, sono ottenute tramite una trapuntatura che accoppia non solo il rivestimento (tessuto, finta pelle o pelle) e il dacron, ma anche uno strato di gomma con uno spessore di 1 cm. Ogni riga è alta 8 cm.

Il rivestimento del modello Stripes è sempre fisso, sia in tessuto che in pelle e finta pelle.

The STRIPES collection, created by the designer Jérôme Gauthier, was inspired by the typical wooden horizontal slat benches used in public parks in Paris and is characterized by the stripes quilting, that is where the name "Stripes" comes from.

Stripes is a tested sound absorbing model and complies with the U.S. BIFMA standards.

In order to enhance the ergonomics and the comfort of the product, the backrest is equipped with a low back support with an inclination angle of about 22 degrees, so that no further cushions are needed to ensure the sofa comfort.

Seat, backrest and arms have a frame made of 20 and 40 mm multi-ply wooden panels of the highest quality.

The frame resistance is guaranteed by a joint construction.

The seat, which is not equipped with interwoven elastic belts, is made of polyurethane foam CM 40/P kg/m³ 5,9 kPa, with supports in foam SR75 Kg/m³ 15,5 kPa.

Backrest and low back support are made of polyurethane foam CM 40 kg/m³ 5,9 kPa.

Frame and arms are upholstered with polyurethane foam with a density of 40 kg/m³ 5,9 kPa and 75 kg/m³ 15,5 kPa.

The presence of polyurethane aggregates with an overall density of 200 kg/m³, under which there is a 40 x 5 mm metal plate, ensure the product durability over time in the areas which are more subject to deformation.

The external frame side is also lined with a 250 gr. thermo-bonded fibre.

The arms are fixed by means of bolts and bajonet joints.

The polyurethane foam is always CMHR fire-retardant (Combustion Modified High Resilient) according to the British Standard regulations (BS), CAL 117, Class 11M, or, on demand, according to other regulations (such as the German DIN or the NF French regulations).

The typical stripes, which can be horizontal or vertical, are obtained through a quilting process which couples not only the cover material – fabric, artificial leather or leather, wick dacron, but also a 1 cm thick foam layer. Each stripe is 8 cm high.

Fabric, artificial leather and leather covers are always fixed.

Die Kollektion STRIPES, gezeichnet vom Designer Jérôme Gauthier, lehnt sich an die typischen Fassdaubenbänken in den Pariser Parks und ist durch die Streifenabsteppung – daher der Name «Stripes», gekennzeichnet.

Stripes ist ein schallabsorbierendes, getestetes Modell und besteht die US-BIFMA Tests.

Die Ergonomie und der Sitzkomfort des Produkts werden durch die in der Rückenlehne eingearbeitete Nierenschütze gefördert. Diese hat eine Neigung von ca. 22°, so dass zusätzliche Kissen nicht benötigt werden, um die Bequemlichkeit und den Sitzkomfort dieses Produkts zu gewährleisten.

Sitz, Rückenlehne und Seitenteile bestehen aus einem Gestell aus Schichtholzplatten mit einer Dicke von 20 und 40 mm von höchster Qualität.

Die Haltbarkeit des Gestells wird durch eine Steckkonstruktion gewährleistet.

Die Sitzfläche, ohne geflochtene Gummigurtung, besteht aus Polyurethan-Schaumstoff CM 40/P kg/m³ 5,9 kPa, mit Verstärkung in SR75 Kg/m³ 15,5 kPa.

Rückenlehne und Nierenschütze sind mit Polyurethan-Schaumstoff CM 40 kg/m³ 5,9 kPa gepolstert.

Gestell und Seitenteile sind mit Polyurethan-Schaumstoff mit einer Dicke von 40 kg/m³ 5,9 kPa und 75 kg/m³ 15,5 kPa gepolstert.

Die Verwendung von Polyurethan-Schaumstoff-Aggregaten mit einer Gesamtdichte von 200 Kg/m³ in den Punkten, die der Verformung mehr ausgesetzt sind, sichert die Dauerhaftigkeit des Produktes für lange Zeit. Darunter wird zusätzlich eine Metallplatte 40 x 5 mm befestigt.

Die Aussenseiten des Gestells sind zusätzlich mit einer Ummantelung aus thermogebundenen Fasern mit Gewicht 250 Gr. ausgestattet.

Die Seitenteile sind mittels Schrauben und Bajonettverschlüssen befestigt.

Der Polyurethan-Schaumstoff ist immer schwerentflammbar CMHR (Combustion Modified High Resilient), gemäß British Standard (BS), Cal 117, Klasse 11M, oder, auf Anfrage, gemäß anderen Standards, wie beispielsweise den deutschen DIN-Normen oder den französischen NF-Normen.

Die typischen Streifen – Stripes –, die horizontal oder vertikal ausgeführt werden können, erhält man nicht nur durch die Verbindung des Bezugsmaterials – Stoff, Leder oder Kunstleder – mit Dacron, sondern es wird hier auch Schaumstoff mit einer Dicke von 1 cm eingearbeitet. Jeder Streifen ist 8 cm hoch.

Die Modelle der Serie Stripes sind immer festbezogen.

La collection STRIPES, créée par le designer Jérôme Gauthier, est inspirée par les banquettes à lattes de bois horizontales utilisées dans les parcs publics parisiens et est caractérisée par le matelassage à rayures (d'où le nom "Stripes").

Stripes est un modèle testé insonore et est conforme aux tests étasuniens BIFMA.

Pour faciliter l'ergonomie et le confort du produit, le dossier est équipé d'un support lombaire avec un angle d'inclinaison d'environ 22° de telle sorte que des coussins lombaires ne sont pas nécessaires pour assurer le confort.

L'assise, le dossier et les accoudoirs sont composés d'une carcasse en panneaux de multiplis de 20 et 40 mm de premier choix.

La résistance de la carcasse est assurée par une construction avec des joints qui offre des garanties élevées de durée de vie.

L'assise, qui n'a pas de sangles élastiques entrecroisées, est en mousse de polyuréthane CM 40/P kg/m³ 5,9 kPa et renforts avec SR75 kg/m³ 15,5 kPa.

Le dossier et les accoudoirs sont en mousse de polyuréthane CM 40 kg/m³ 5,9 kPa.

La carcasse et les accoudoirs sont revêtus de mousse de polyuréthane avec une densité de 40 kg/m³ 5,9 kPa et 75 kg/m³ 15,5 kPa.

Afin d'assurer la durabilité du produit dans le temps au niveau des points les plus sujets à la déformation, des agrégats de mousse de polyuréthane d'une densité globale de 200 kg/m³ sont utilisés, sous lesquels est montée une plaque métallique de 40 x 5 mm.

En plus, l'extérieur de la carcasse est revêtu de dacron de 250 grammes.

Les accoudoirs sont fixés à l'aide de boulons et baionnettes.

La mousse de polyuréthane est toujours ignifuge CMHR (Combustion Modified High Resilient) et répond aux normes British Standard (BS), Cal 117, Classe 11M, ainsi que, sur demande, à d'autres normes (par exemple les normes allemandes DIN ou les normes françaises NF).

Les rayures ("stripes" en anglais) caractéristiques, horizontales ou verticales, sont obtenues grâce à un matelassage qui couple non seulement le revêtement (tissu, similicuir ou cuir) et le dacron, mais aussi une couche de mousse de polyuréthane avec une épaisseur d'1 cm. Chaque rayure est haute 8 cm.

Le revêtement du modèle Stripes est toujours fixe, aussi bien en tissu qu'en similicuir qu'en cuir.

Ottimale caratteristica della collezione STRIPES è la presenza di una stecca in legno orizzontale utilizzata nei parchi pubblici parigini ed è caratterizzata dalla trapuntatura a righe (da cui viene il nome "Stripes").

Stripes è un modello testato fonoadassorbente ed è conforme ai test BIFMA statunitensi. Per favorire l'ergonomia e la comodità del prodotto, lo schienale è dotato di un poggiaerani con un angolo di inclinazione di ca. 22° in modo tale che non sono necessari cuscinetti per garantire il comfort.

Seduta, schienale e braccioli sono composti da un fusto in pannelli di multistrato da 20 e 40 mm di prima scelta. La resistenza del fusto è garantita da una costruzione ad incastri che offre elevate garanzie di tenuta.

La seduta, priva di cinghie elastiche intrecciate, è in poliuretano espanso CM 40/P kg/m³ 5,9 kPa e rinforzi con SR75 Kg/m³ 15,5 kPa.

Schienale e poggiaerani sono in poliuretano espanso CM 40 kg/m³ 5,9 kPa.

Il fusto e i braccioli sono rivestiti in poliuretano espanso, con una densità di 40 kg/m³ 5,9 kPa e 75 kg/m³ 15,5 kPa.

Per garantire la durabilità del prodotto nel tempo nei punti maggiormente soggetti a deformazione vengono utilizzati degli aggregati di poliuretano espanso della densità complessiva di 200 kg/m³, sotto cui è montata una piastra di metallo da 40 x 5 mm.

La parte esterna del fusto è inoltre rivestita in fibra termolegata di 250 gr.

I braccioli sono fissati tramite bulloni e baionette.

Il poliuretano espanso è sempre ignifugo CMHR (Combustion Modified High Resilient) e risponde alle norme British Standard (BS), Cal 117, Classe 11M, nonché, su richiesta, ad altri standard (per esempio le norme tedesche DIN o le norme francesi NF).

Le caratteristiche righe ("stripes" in inglese), orizzontali o verticali, sono ottenute tramite una trapuntatura che accoppia non solo il rivestimento (tessuto, finta pelle o pelle) e il dacron, ma anche uno strato di gomma con uno spessore di 1 cm. Ogni riga è alta 8 cm.

Il rivestimento del modello Stripes è sempre fisso, sia in tessuto che in pelle e finta pelle.

Stripes è un modello testato fonoadassorbente ed è conforme ai test BIFMA statunitensi.

Per favorire l'ergonomia e la comodità del prodotto, lo schienale è dotato di un poggiaerani con un angolo di inclinazione di ca. 22° in modo tale che non sono necessari cuscinetti per garantire il comfort.

Seduta, schienale e braccioli sono composti da un fusto in pannelli di multistrato da 20 e 40 mm di prima scelta. La resistenza del fusto è garantita da una costruzione ad incastri che offre elevate garanzie di tenuta.

La seduta, priva di cinghie elastiche intrecciate, è in poliuretano espanso CM 40/P kg/m³ 5,9 kPa e rinforzi con SR75 Kg/m³ 15,5 kPa.

Schienale e poggiaerani sono in poliuretano espanso CM 40 kg/m³ 5,9 kPa.

Il fusto e i braccioli sono rivestiti in poliuretano espanso, con una densità di 40 kg/m³ 5,9 kPa e 75 kg/m³ 15,5 kPa.

Per garantire la durabilità del prodotto nel tempo nei punti maggiormente soggetti a deformazione vengono utilizzati degli aggregati di poliuretano espanso della densità complessiva di 200 kg/m³, sotto cui è montata una piastra di metallo da 40 x 5 mm.

La parte esterna del fusto è inoltre rivestita in fibra termolegata di 250 gr.

I braccioli sono fissati tramite bulloni e baionette.

Il poliuretano espanso è sempre ignifugo CMHR (Combustion Modified High Resilient) e risponde alle norme British Standard (BS), Cal 117, Classe 11M, nonché, su richiesta, ad altri standard (per esempio le norme tedesche DIN o le norme francesi NF).

Le caratteristiche righe ("stripes" in inglese), orizzontali o verticali, sono ottenute tramite una trapuntatura che accoppia non solo il rivestimento (tessuto, finta pelle o pelle) e il dacron, ma anche uno strato di gomma con uno spessore di 1 cm. Ogni riga è alta 8 cm.

Il rivestimento del modello Stripes è sempre fisso, sia in tessuto che in pelle e finta pelle.

Stripes è un modello testato fonoadassorbente ed è conforme ai test BIFMA statunitensi.

Per favorire l'ergonomia e la comodità del prodotto, lo schienale è dotato di un poggiaerani con un angolo di inclinazione di ca. 22° in modo tale che non sono necessari cuscinetti per garantire il comfort.

Seduta, schienale e braccioli sono composti da un fusto in pannelli di multistrato da 20 e 40 mm di prima scelta. La resistenza del fusto è garantita da una costruzione ad incastri che offre elevate garanzie di tenuta.

La seduta, priva di cinghie elastiche intrecciate, è in poliuretano espanso CM 40/P kg/m³ 5,9 kPa e rinforzi con SR75 Kg/m³ 15,5 kPa.

Schienale e poggiaerani sono in poliuretano espanso CM 40 kg/m³ 5,9 kPa.

Il fusto e i braccioli sono rivestiti in poliuretano espanso, con una densità di 40 kg/m³ 5,9 kPa e 75 kg/m³ 15,5 kPa.

Per garantire la durabilità del prodotto nel tempo nei punti maggiormente soggetti a deformazione vengono utilizzati degli aggregati di poliuretano espanso della densità complessiva di 200 kg/m³, sotto cui è montata una piastra di metallo da 40 x 5 mm.

La parte esterna del fusto è inoltre rivestita in fibra termolegata di 250 gr.

L&H SOFA 2012

L-Sofa & H-Sofa offer a complete seating sofa solution.

Longitudinal wooden panels hold, on the one hand, the base structure and, on the other hand, the L molded plywood for the seating, high back and armrest cushions. These elements are common features of the L-Sofa and H-Sofa range.

The leg length which is proportionate to the height of the plywood L are key features of these two lines of sofas that can be extensible and adjustable over and over.

The L frames are available in different wood material, lacquered wood and various colors in order to go with the cushions available in a wide range of fabrics, leathers and colors.

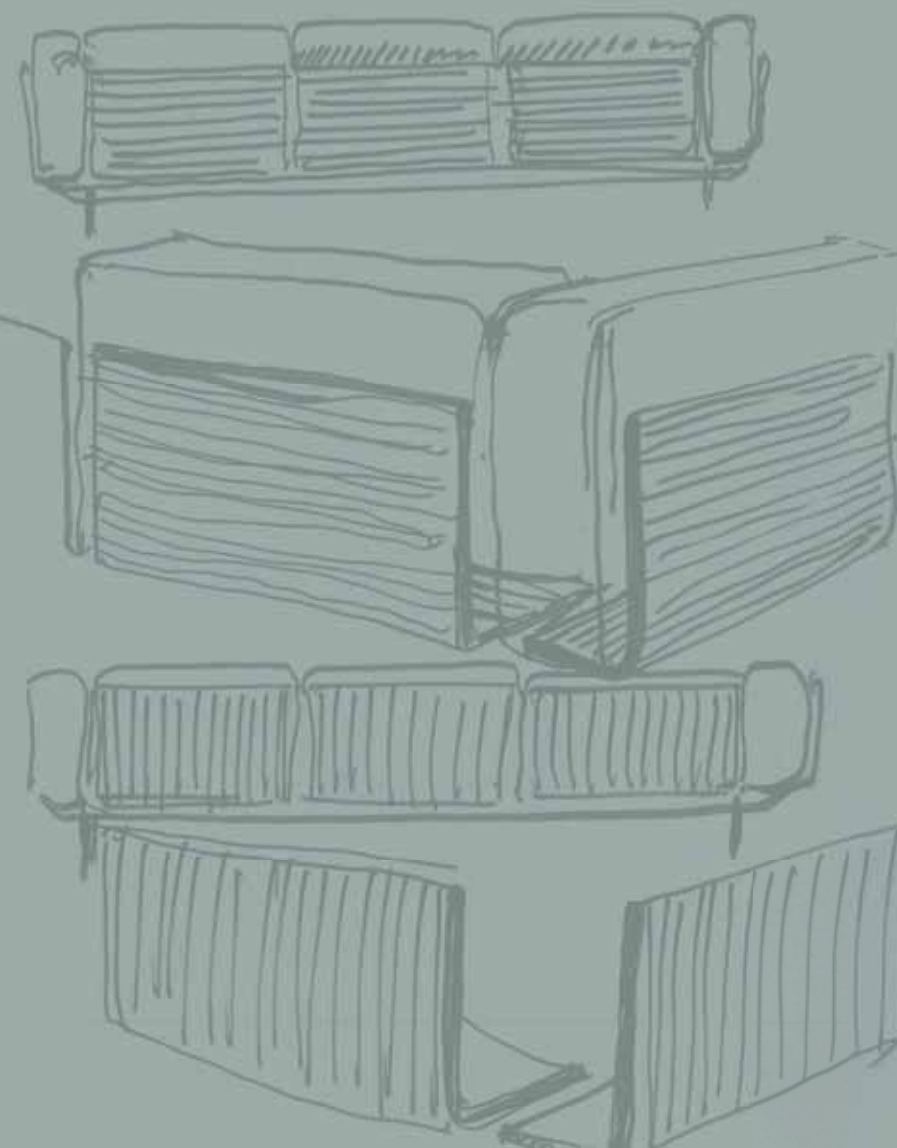

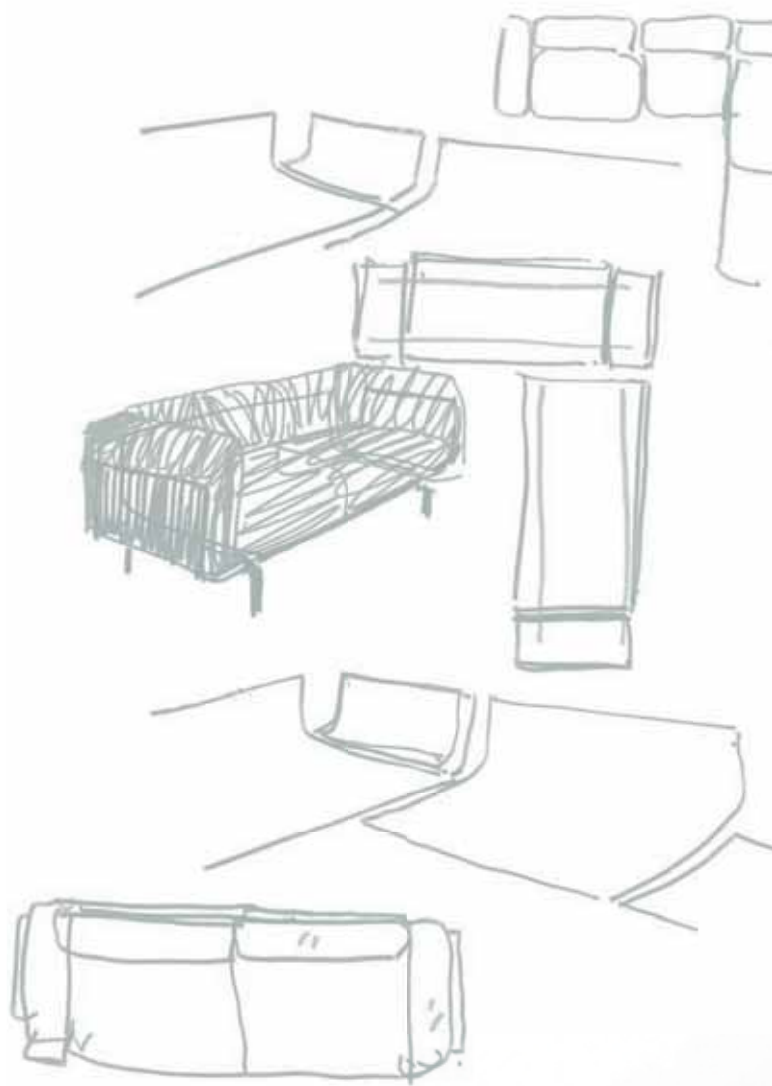
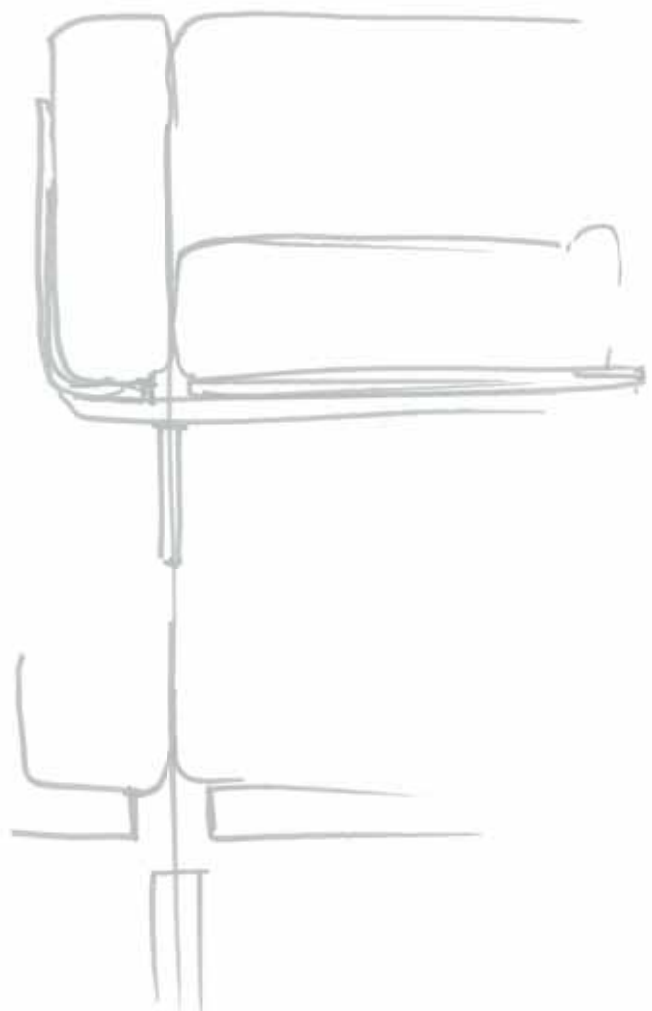





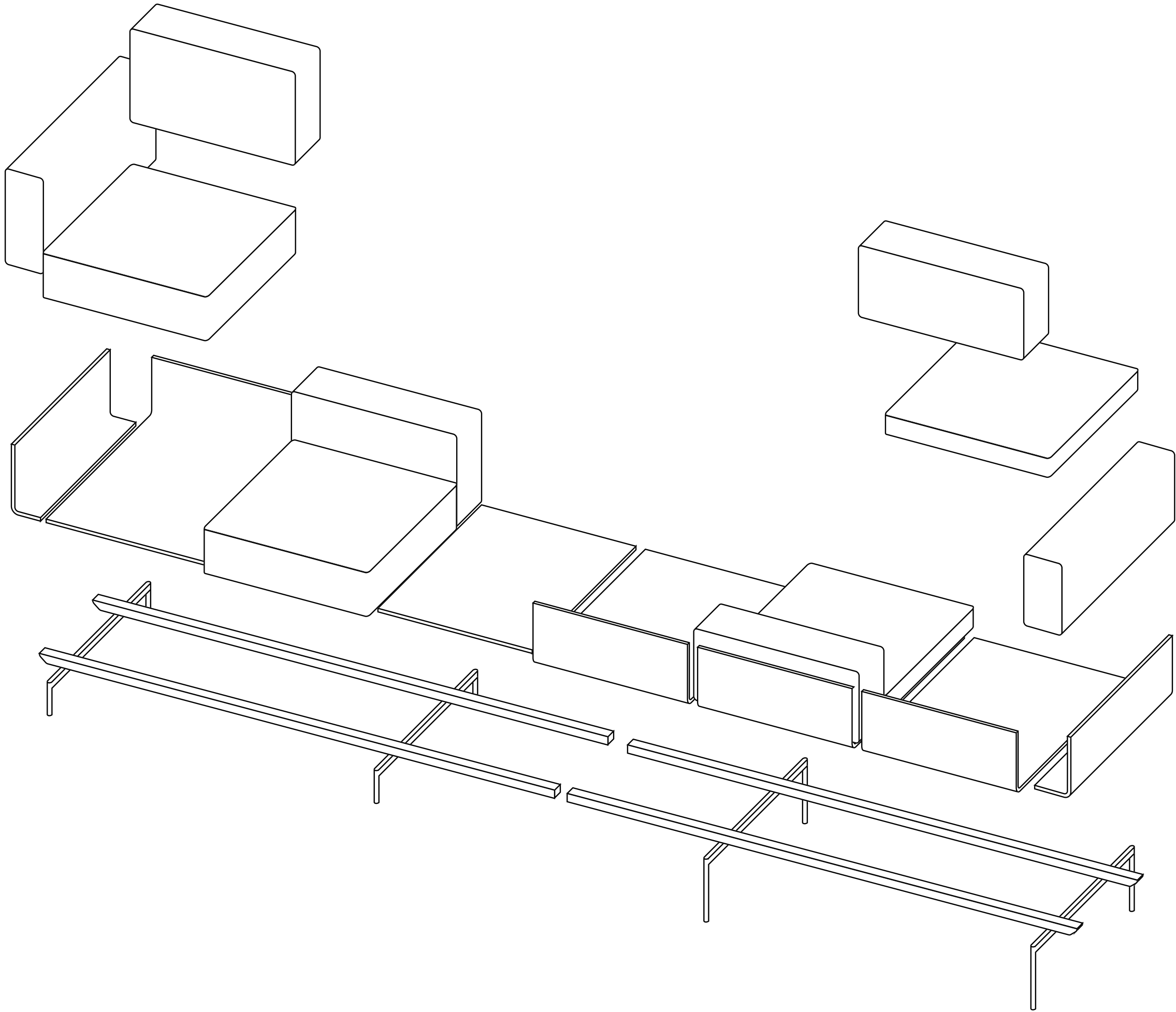

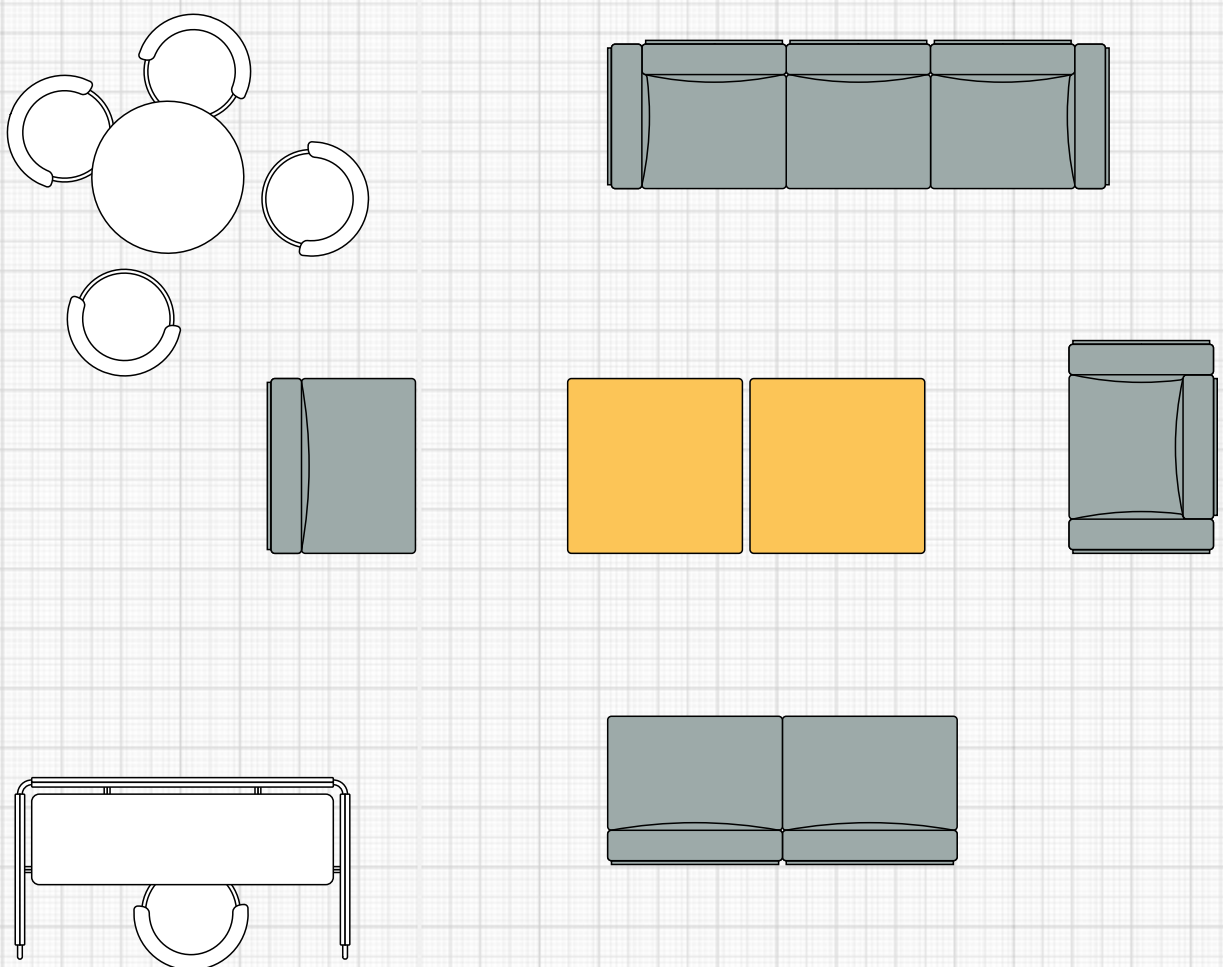
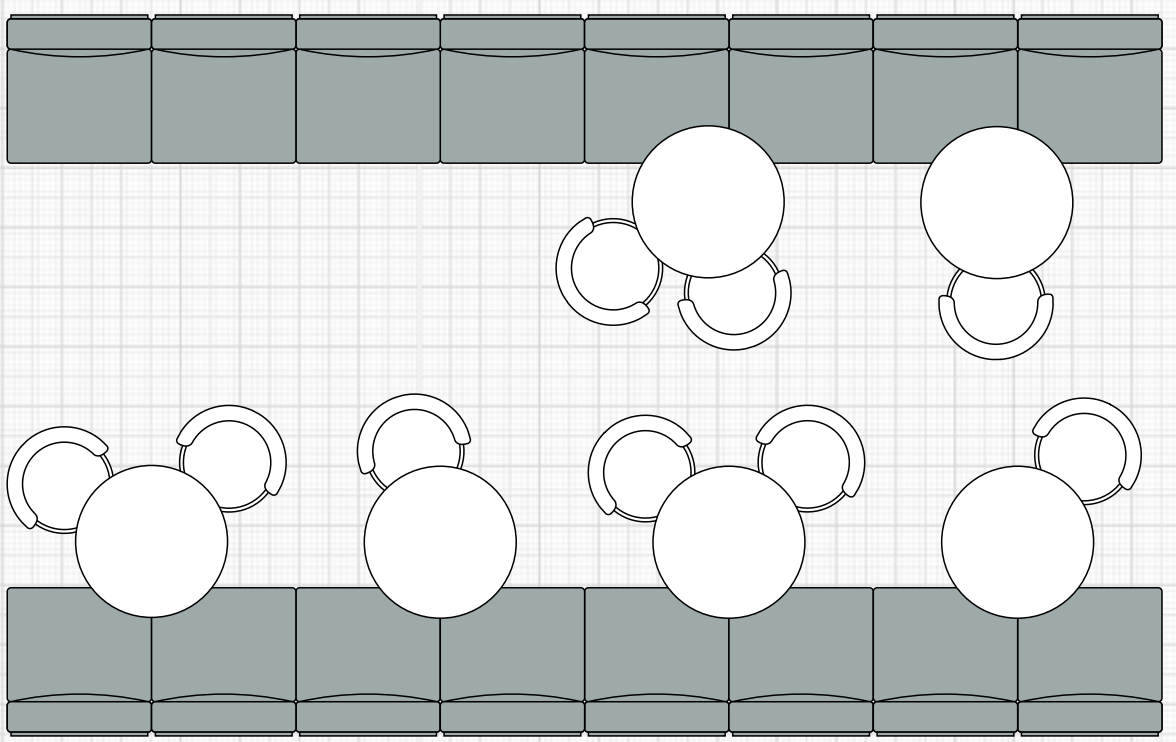
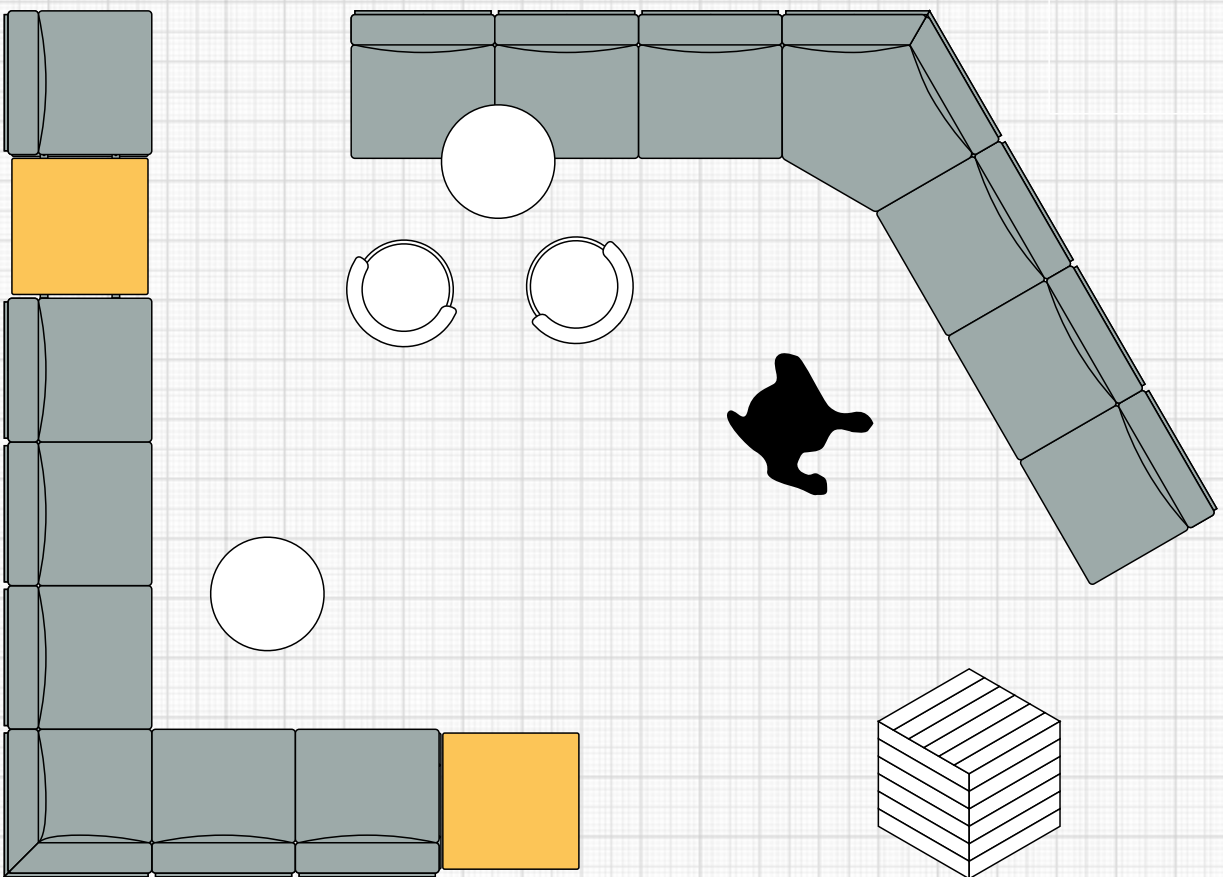
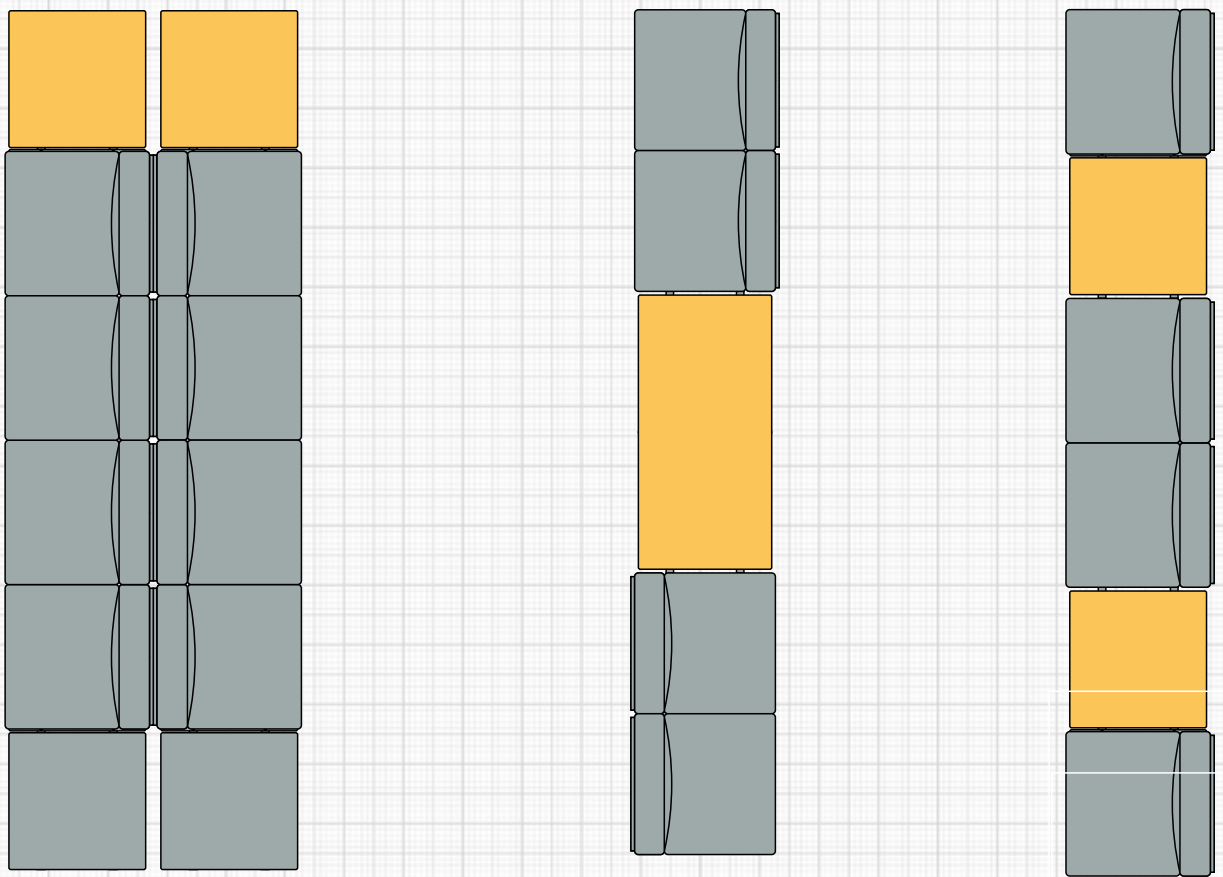





L-SOFA armchair
9LF102 cm 128x78x70h
Leather: cat. Super art. Dollaro col. 7110
Oak panels: RAL 7016 anthracite grey
Metal base: OPM2 matt brushed chrome



L-SOFA sofa
9LF207 cm 260x78x70h
Fabric: cat. B art. Gabriel Atlantic col. 61078
Oak panels: OPR4 natural oak
Metal base: OPM6 RAL 9017 traffic black painted



L-SOFA composition
9LF209 with table cm 184x78x70h
9LF206 cm 184x78x70h
 Fabric: cat. C art. Gabriel Step Melange col. 61104
 Oak panels: OPR4 natural oak
 Metal base: OPM6 RAL 9017 traffic black painted

L-SOFA
9LF206 cm 184x78x70h
 Fabric: cat. C art. Gabriel Step Melange col. 60021
 Oak panels: OPR4 natural oak
 Metal base: OPM6 RAL 9017 traffic black painted

PIVOT table
7PIV101 ø cm 60x43/61h
 OPR4 natural oak

PIVOT table
7PIV102 ø cm 78x43/74h
 OPR4 natural oak

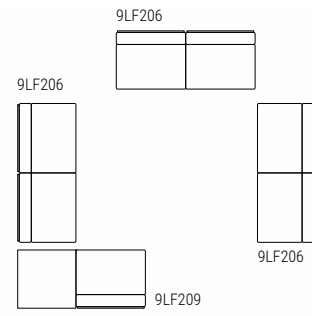



H-SOFA sofa
9HS205 cm 193x77x74h
Fabric: cat. H art. Kvadrat Hallingdal 65 col. 547
Oak panels: OPR5 black stained
Metal base: OPM6 RAL 9017 traffic black painted



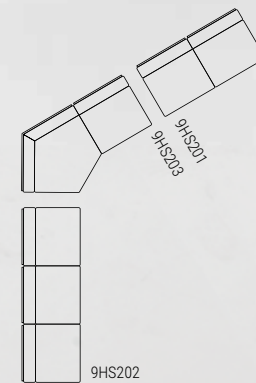

H-SOFA composition cm 308x308h
9HS202 cm 231x77x74h
9HS203 cm 190x77x74h
9HS201 cm 154x77x74h
 Fabric: cat. B art. Gabriel Atlantic col. 61163
 Oak panels: OPR4 natural oak
 Metal base: OPM6 RAL 9017 traffic black painted

PIVOT swivel chairs
9PIV101 cm 55.5x54x80h
 Fabric: cat. B art. Gabriel Atlantic col. 62048
 Oak structure in natural oak OPR4

PIVOT table
7PIV101 ø cm 60x43/61h
 OPR4 natural oak

PIVOT table
7PIV102 ø cm 78x43/74h
 OPR4 natural oak



9HS204

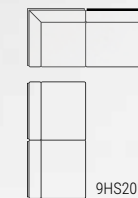

9HS203

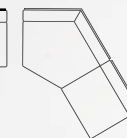

9HS201



9HS202

H-SOFA composition**9HS203 cm 190x77x74h****9HS204 cm 154x77x74h****9HS201 cm 154x77x74h****9HS202 cm 231x77x74h**

Fabric: cat. H art. Kvadrat Remix 2 col. 933

Oak panels: OPR4 natural oak

Metal base: OPM7 RAL 9016 traffic white painted

PIVOT swivel chairs**9PIV101 cm 55.5x54x80h**

Fabric: cat. B art. Gabriel Atlantic col. 61163

Oak structure in natural oak OPR4

PIVOT table**7PIV101 ø cm 60x43/61h**

OPR4 natural oak

PIVOT table**7PIV102 ø cm 78x43/74h**

OPR4 natural oak

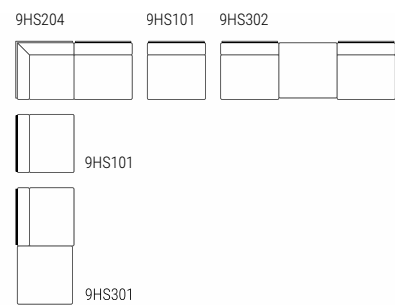

H-SOFA composition cm 308x462:

9HS301 cm 154x77x74h

9HS101 cm 77x77x74h

9HS204 cm 154x77x74h

9HS101 cm 77x77x74h

9HS302 with table cm 231x77x74h

Fabric: cat. B art. Gabriel Atlantic col. 60063 beige

Oak panels and table tops: OPR4 natural oak

Metal base: OPM6 RAL 9017 traffic black painted

9SS805 Belux lamps

9SS802 Schulte Evoline sockets



L-SOFA

DESIGN JÉRÔME GAUTHIER
2012

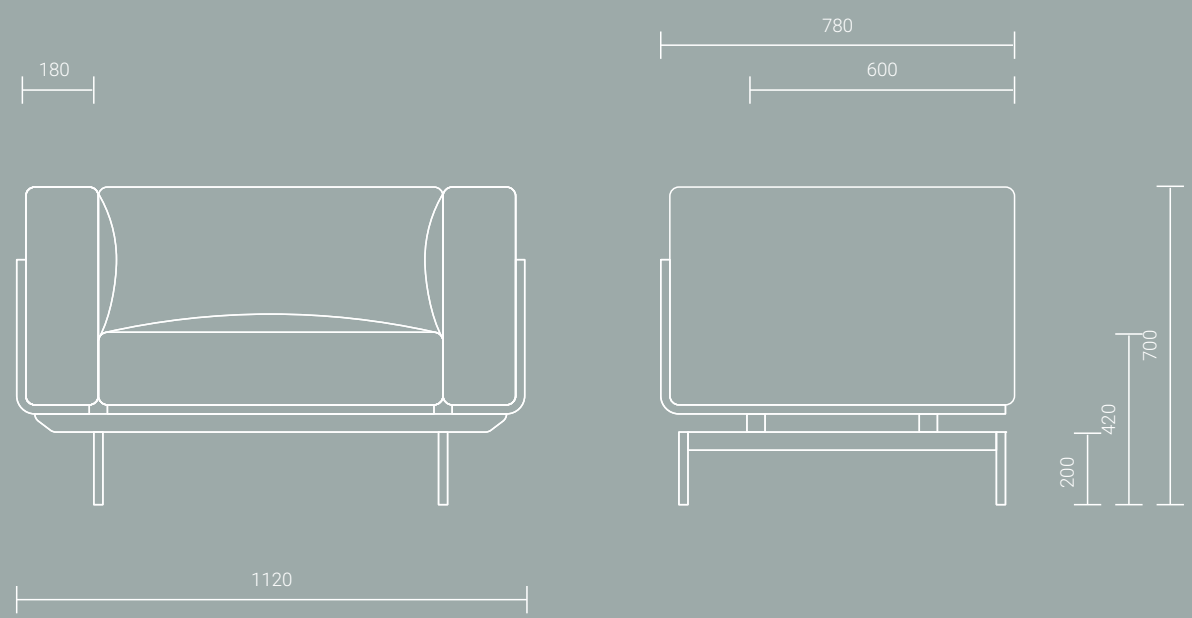

Sofas

Modular elements

Pouf and accessories

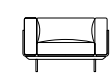

9LF101
L112 P78 H70

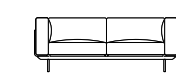

9LF201
L188 P78 H70

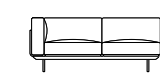

9LF203
L170 P78 H70

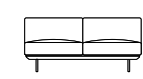

9LF205
L152 P78 H70

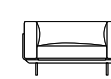

9LF102
L128 P78 H70

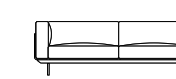

9LF202
L220 P78 H70

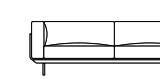

9LF204
L202 P78 H70

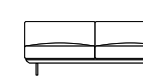

9LF206
L184 P78 H70

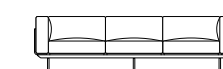

9LF207
L260 P78 H70

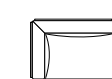

9LF103
L110 P78 H70



9LF104
L92 P78 H70

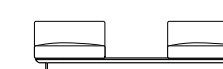

9LF208
L276 P78 H70

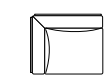

9LF107
L94 P78 H70



9LF108
L76 P78 H70

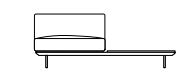

9LF209
L184 P78 H70

Wood Top

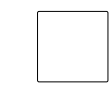

9LF105
L92 P92 H42

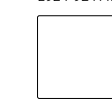

7LF101
L92 P92 H23



9LF106
L108 P108 H42

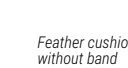

7LF102
L108 P108 H23

Feather cushion
without band



9RL112
L63 H33

L-SOFA

DESIGN JÉRÔME GAUTHIER

Struttura portante costituita da due tubolari di metallo cm 4 x 3. Piede in metallo diametro cm 2,5. Pannelli in multistrato impiallacciato rovere, spessore 2,1 cm. Cuscini in poliuretano espanso a quote differenziate, rivestito in dacron 100 gr: sedile T.40RC (kPa5); schienale PF30 (kPa4,3), PF30M (kPa 3,5), T.30HR (kPa 1,5); braccioli PF30 (kPa 4,3), T.30HR (kPa 1,5). Il rivestimento è sempre fisso.

Structure portante constituée de deux tubes en métal de 4 x 3 cm. Pied en métal diamètre 2,5 cm. Panneaux en multiplis plaqués chêne, épaisseur 2,1 cm. Coussins en mousse polyuréthane de différentes densités, revêtue de dacron 100 g: assise T.40RC (kPa5); dossier PF30 (kPa4,3), PF30M (kPa 3,5), T.30HR (kPa 1,5); accoudoirs PF30 (kPa 4,3), T.30HR (kPa 1,5). Le revêtement est toujours fixe.

Frame made of two metal tubes cm 4 x 3. Metal leg diameter cm 2.5. Multiply oak veneer panels, 2.1 cm thick. Cushions made of polyurethane foam in different densities, covered with dacron 100 gr: seat T.40RC (kPa5); back PF30 (kPa4,3), PF30M (kPa 3,5), T.30HR (kPa 1,5); armrests PF30 (kPa 4,3), T.30HR (kPa 1,5). Covers are always fixed.

Несущий каркас образован двумя металлическими планками, размер в сечении 4 x 3 см. Металлические ножки диаметром 2,5 см. Панели из многослойной фанеры, отделанной шпоном дуба, толщина панели 2,1 см. Наполнение подушек: вспененный полиуретан с участками различной плотности в чехле из дакрона весом 100 гр. Подушка сиденья T.40RC (kPa5); подушка спинки schienale PF30 (kPa4,3), PF30M (kPa 3,5), T.30HR (kPa 1,5); подлокотники PF30 (kPa 4,3), T.30HR (kPa 1,5). Чехлы несъемные.

Gestellkonstruktion mit 2 Querträgern 4-Kantrohr 4 x 3 cm, Metallfüsse mit Durchmesser 2,5 cm. Rücken- und Armlehnelemente aus Schichtholz Eiche furniert, Dicke 2,1 cm. Kissen aus Polyurethanschaumstoff in unterschiedlichen Dichten, mit Dacron 100 gr ummantelt: Sitzkissen T.40RC (kPa5); Rückenissen PF30 (kPa4,3), PF30M (kPa 3,5), T.30HR (kPa 1,5); Armlehnkissen PF30 (kPa 4,3), T.30HR (kPa 1,5). L-Sofa ist immer fix bezogen.

Optionals



9SS802
L10 P10
Schulte Evoline socket















9SS805
ø14 P32
Belux lamp









9SS811
Castors

Finishes











Wooden panels and tables tops

									
Code	Cherry stained oak OPR1	Wengé stained oak OPR2	Walnut stained oak OPR3	Natural oak OPR4	Black stained oak OPR5	Cherry Milano stained oak OPR6	Tobacco stained oak OPR8	Grey taupe stained oak OPR9	Whitened oak OPR10
									
Code	Charcoal stained oak OPR11	Mahogany stained oak OPR12	Oak painted in RAL Classic colours OPR14	Moka matt stained oak OPR15					









Standard base finishes

									
Code	RAL 9017 traffic black painted metal OPM6	RAL 9016 traffic white painted metal OPM7	Classic bronze painted metal OPM9	RAL 9006 white aluminium painted metal OPM10	Golden beach painted metal OPM10	Gold pearl painted metal OPM11	Anodyc Bronze metal OPM18		

Optional base finishes

										
Code	Shiny chrome metal OPM1	Brushed matt chrome metal OPM2	Brushed matt dark grey metal OPM3	Metal painted in RAL Classic colours OPM8	Brushed copper metal OPM12	Brushed antique brass metal OPM13	Shiny black chrome metal OPM14	Brushed antique gold metal OPM15	Shiny brass chrome metal OPM16	Bronze metal OPM17

Marble top finishes

									
Code	White Carrara marble OPP1	Black Marquina marble OPP2	Brown Emperador marble OPP3	Calacatta gold marble OPP7	Black and gold marble OPP9	Perfetto brown marble OPP10	Grey Stone marble OPP11	Guatemala green marble OPP12	Velvet brown marble OPP13

H-SOFA

DESIGN JÉRÔME GAUTHIER

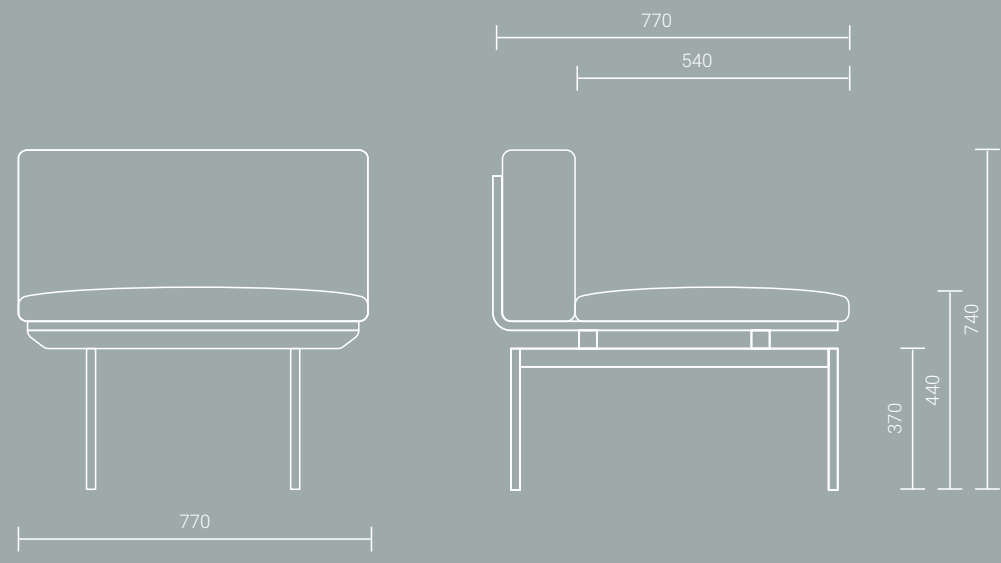

Sofas



9HS101
L77 P77 H74

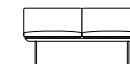

9HS201
L154 P77 H74

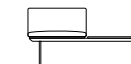

9HS301
L154 P77 H74

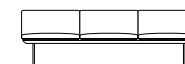
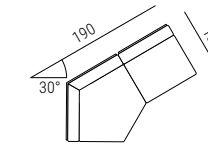

9HS202
L231 P77 H74

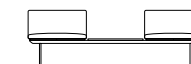

9HS302
L231 P77 H74

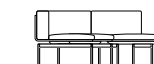

9HS203
L190 P77 H74

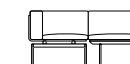

9HS204
L154 P77 H74



9HS102
L113 P77 H74

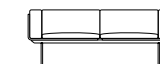

9HS205
L193 P77 H74

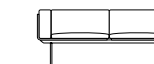

9HS206
L172 P77 H74



9HS207
L154 P77 H50



9HS208
L154 P77 H50

Optionals



9SS802
L10 P10
Schulte Evoline socket



9SS805
ø14 P32
Belux lamp

H-SOFA

DESIGN JÉRÔME GAUTHIER
2012

Struttura portante costituita da due tubolari di metallo cm 4 x 3. Piede in metallo diametro cm 2,5. Pannelli in multistrato impiallacciato rovere, spessore 2,1 cm.
Cuscini in poliuretano espanso a quote differenziate, rivestito in dacron 100 gr: sedile T.40RC (kPa5); schienale PF30 (kPa4,3), PF30M (kPa 3,5), T.30HR (kPa 1,5); braccioli PF30 (kPa 4,3), T.30HR (kPa 1,5). Il rivestimento è sempre fisso.

Structure portante constituée de deux tubes en métal de 4 x 3 cm. Pied en métal diamètre 2,5 cm. Panneaux en multiplis plaqués chêne, épaisseur 2,1 cm. Coussins en mousse polyuréthane de différentes densités, revêtu de dacron 100 g: assise T.40RC (kPa5); dossier PF30 (kPa4,3), PF30M (kPa 3,5), T.30HR (kPa 1,5); accoudoirs PF30 (kPa 4,3), T.30HR (kPa 1,5). Le revêtement est toujours fixe.













Frame made of two metal tubes cm 4 x 3. Metal leg diameter cm 2.5. Multiply oak veneer panels, 2.1 cm thick. Cushions made of polyurethane foam in different densities, covered with dacron 100 gr: seat T.40RC (kPa5); back PF30 (kPa4,3), PF30M (kPa 3,5), T.30HR (kPa 1,5); armrests PF30 (kPa 4,3), T.30HR (kPa 1,5). Covers are always fixed.

Несущий каркас образован двумя металлическими планками, размер в сечении 4 x 3см Металлические ножки диаметром 2,5см Панели из многослойной фанеры, отделанной шпоном дуба, толщина панели 2,1см Наполнение подушек: вспененный полиуретан с участками различной плотности в чехле из дакрона весом 100гр Подушка сиденья T.40RC (kPa5); подушка спинки schienale PF30 (kPa4,3), PF30M (kPa 3,5), T.30HR (kPa 1,5); подлокотники PF30 (kPa 4,3), T.30HR (kPa 1,5). Чехлы несъемные.





Gestellkonstruktion mit 2 Querträgern 4-Kantrohr 4 x 3 cm, Metallfüsse mit Durchmesser 2,5 cm. Rücken- und Armlehnelemente aus Schichtholz Eiche furniert, Dicke 2,1 cm. Kissen aus Polyurethanschäumstoff in unterschiedlichen Dichten, mit Dacron 100 gr ummantelt: Sitzkissen T.40RC (kPa5); Rückenissen PF30 (kPa4,3), PF30M (kPa 3,5), T.30HR (kPa 1,5); Armlehnkissen PF30 (kPa 4,3), T.30HR (kPa 1,5). L-Sofa ist immer fix bezogen.

Finishes











Wooden panels and tables tops

									
Code	Cherry stained oak OPR1	Wengé stained oak OPR2	Walnut stained oak OPR3	Natural oak OPR4	Black stained oak OPR5	Cherry Milano stained oak OPR6	Tobacco stained oak OPR8	Grey taupe stained oak OPR9	Whitened oak OPR10
									
Code	Charcoal stained oak OPR11	Mahogany stained oak OPR12	Oak painted in RAL Classic colours OPR14	Moka matt stained oak OPR15					









Standard base finishes

										
Code	RAL 9017 traffic black painted metal OPM6	RAL 9016 traffic white painted metal OPM7	Classic bronze painted metal OPM9	RAL 9006 white aluminium painted metal	Golden beach painted metal OPM10	Gold pearl painted metal OPM11	Anodyc Bronze metal OPM18			

Optional base finishes

										
Code	Shiny chrome metal OPM1	Brushed matt chrome metal OPM2	Brushed matt dark grey metal OPM3	Metal painted in RAL Classic colors OPM8	Brushed copper metal OPM12	Brushed antique brass metal OPM13	Shiny black chrome metal OPM14	Brushed antique gold metal OPM15	Shiny brass chrome metal OPM16	Bronze metal OPM17

Marble top finishes

									
Code	White Carrara marble OPP1	Black Marquinia marble OPP2	Brown Emperador marble OPP3	Calacatta gold marble OPP7	Black and gold marble OPP9	Perfetto brown marble OPP10	Grey Stone marble OPP11	Guatemala green marble OPP12	Velvet brown marble OPP13

ASSEMBLAGE

Assembly tables are originated, drawn and based on the link piece developed for the Pendrillon program.

Minimalist and ingenious, this principle consists in uniting a vertical upright support in steel tube to a horizontal plywood or marble top thanks to this rigid cast aluminum clamp.

Tables, sofa ends, shelves... a whole range of products is designed from this unique assembly system.

The quadrature of the circle: economy, solidity, warmth, and aesthetics are here combined.



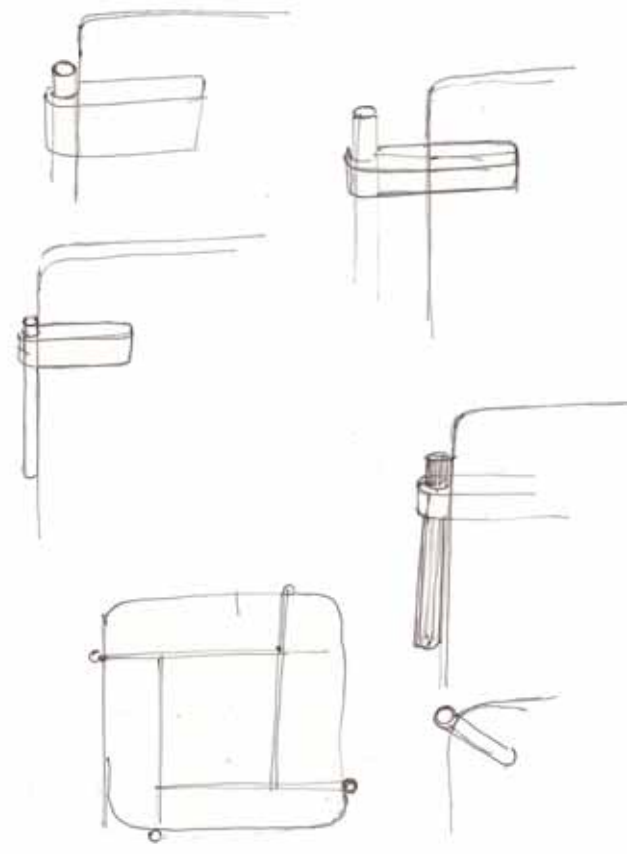







ASSEMBLAGE

DESIGN JÉRÔME GAUTHIER
2018

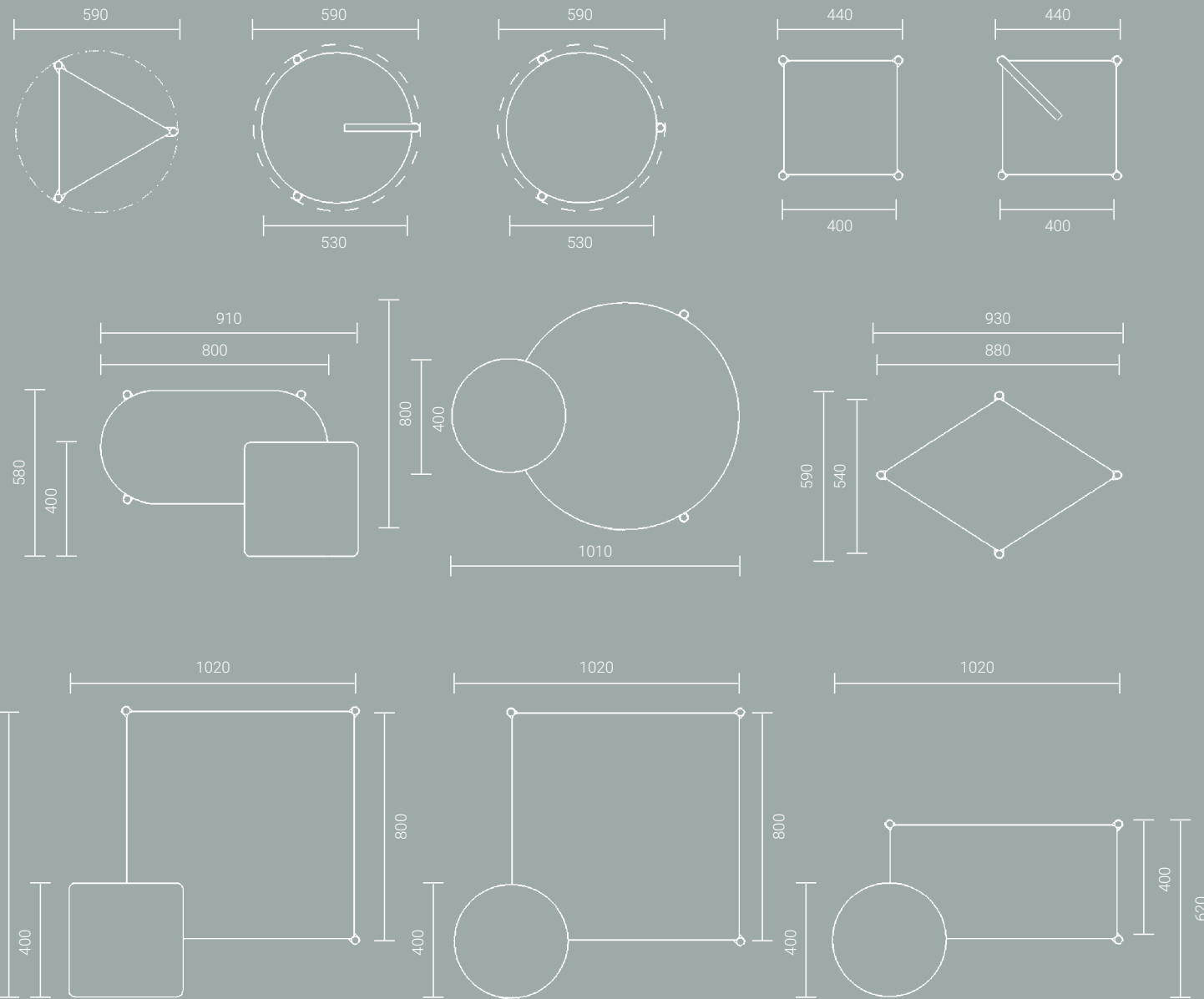

Legs

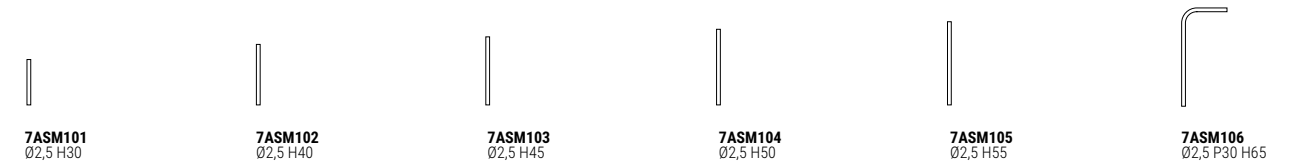

Metal upper tops

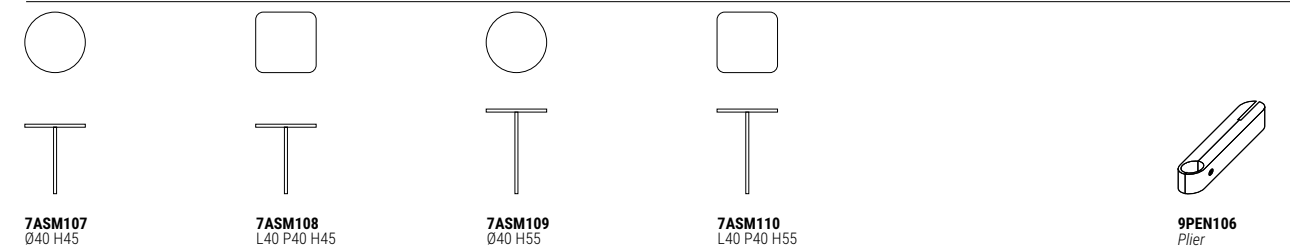

Oak tops

Marble tops

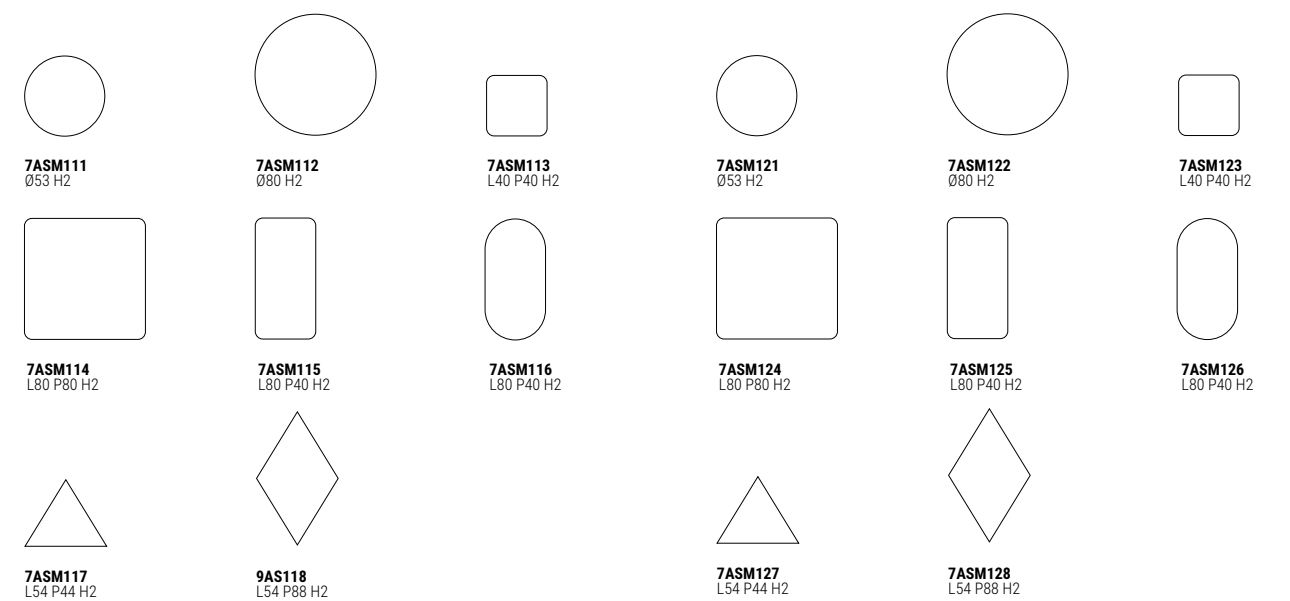

ASSEMBLAGE

DESIGN JÉRÔME GAUTHIER

Compositions

COMPOSITION A

7ASM101 x2
RAL 3011 brown red painted metal legs
9PEN106 x3
RAL 3011 brown red painted metal pliers
7ASM107
RAL 3011 brown red painted metal metal leg with round metal top
7ASM122
OPP1 Carrara white marble top

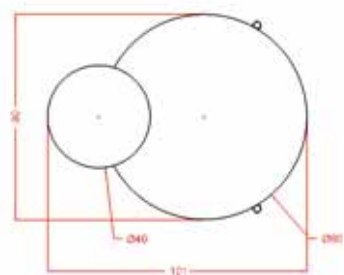

COMPOSITION B

7ASM101 x3
RAL 3017 traffic black painted metal legs
9PEN106 x4
RAL 3017 traffic black painted metal pliers
7ASM108
RAL 1005 honey yellow metal leg with square metal top
7ASM124
OPP2 Marquina black marble top

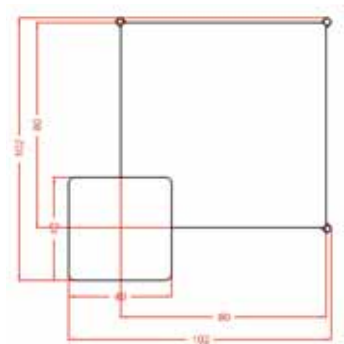

COMPOSITION C

7ASM101 x3
RAL 3011 brown red painted metal legs
9PEN106 x4
RAL 3011 brown red painted metal pliers
7ASM107
RAL 3011 brown red painted metal leg with round metal top
7ASM114
OPR4 natural oak top

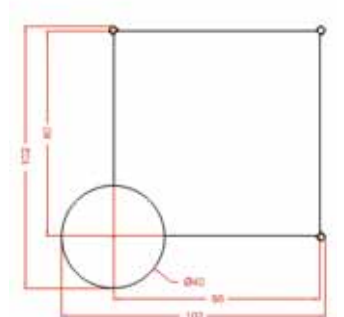

Compositions

COMPOSITION D

7ASM102 x3
RAL 3011 brown red painted metal legs
9PEN106 x4
RAL 3011 brown red painted metal pliers
7ASM110
RAL 3011 brown red painted metal leg with square metal top
7ASM126
OPP12 Guatemala green marble top

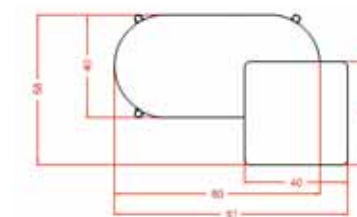

COMPOSITION E

7ASM102 x3
RAL 6009 fir green painted metal legs
9PEN106 x3
RAL 6009 fir green painted metal pliers
7ASM117
OPR4 natural oak top



COMPOSITION F

7ASM102 x4
RAL 9016 traffic white painted metal legs
9PEN106 x4
RAL 9016 traffic white painted metal pliers
7ASM123
OPP1 Carrara white marble top

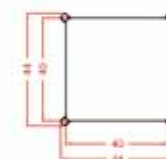

ASSEMBLAGE

DESIGN JÉRÔME GAUTHIER

Compositions

COMPOSITION G

7ASM103 x4
RAL 3011 brown red painted metal legs
9PEN106 x4
RAL 3011 brown red painted metal pliers
7ASM118
OPR3 walnut stained oak top

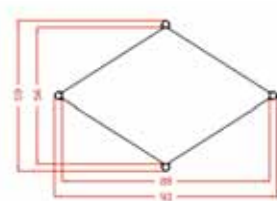

COMPOSITION H

7ASM104 x3
RAL 9017 traffic black painted metal legs
9PEN106 x3
RAL 9017 traffic black painted metal pliers
7ASM111
OPR5 black stained oak top

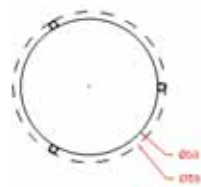

COMPOSITION I:

7ASM103 x3
RAL 6009 fir green painted metal legs
9PEN106 x4
RAL 6009 fir green painted metal pliers
7ASM109
RAL 6009 fir green metal leg with round metal top
7ASM115
OPR4 natural oak top

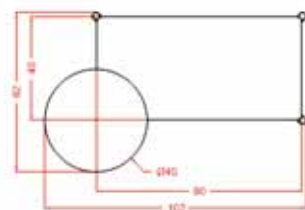

Compositions

COMPOSITION J

7ASM104 x2
RAL 9017 traffic black painted metal legs
7ASM106
RAL 1005 honey yellow metal leg
9PEN106 x3
RAL 9017 traffic black painted metal pliers
7ASM111
OPR5 black stained oak top

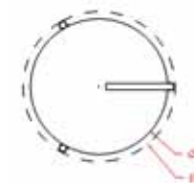

COMPOSITION K



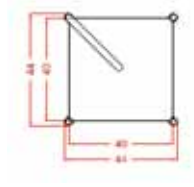

























7ASM104 x3
RAL 9017 traffic black painted legs
7ASM106
RAL 3011 brown red painted metal leg
9PEN106 x4
RAL 9017 traffic black and RAL 3011 brown red painted metal pliers
7ASM113
OPR5 black stained oak top



ASSEMBLAGE

DESIGN JÉRÔME GAUTHIER

Finishes

<i>Standard finish for metal parts</i>									
									
Code	RAL 9017 traffic black painted metal OPM6								
<i>Optional finishes for metal parts</i>									
									
Code	RAL 9016 traffic white painted metal OPM7	Metal painted in RAL Classic colors OPM8	Classic bronze painted metal OPM9	Golden beach painted metal OPM10	Gold pearl painted metal OPM11	Anodyc Bronze metal OPM18			
<i>Oak finishes for table tops</i>									
									
Code	Cherry stained oak OPR1	Wengé stained oak OPR2	Walnut stained oak OPR3	Natural oak OPR4	Black stained oak OPR5	Cherry Milano stained oak OPR6	Tobacco stained oak OPR8	Grey taupe stained oak OPR9	Whitened oak OPR10
									
Code	Charcoal stained oak OPR11	Mahogany stained oak OPR12	Oak painted in RAL Classic colours OPR14	Moka matt stained oak OPR15					
<i>Marble finishes for tables tops</i>									
									
Code	White Carrara marble OPP1	Black Marquina marble OPP2	Brown Emperador marble OPP3	Calacatta gold marble OPP7	Black and gold marble OPP9	Perfetto brown marble OPP10	Grey Stone marble OPP11	Guatemala green marble OPP12	Velvet brown marble OPP13

J E R O M E
G A U T H I E R
S T U D I O

STRIPES
PAG.114

TABLES FINISHES

MELAMINE SAMPLES



Whitened oak



Taupe oak



Tabacco oak



Grey oak



Wengé oak

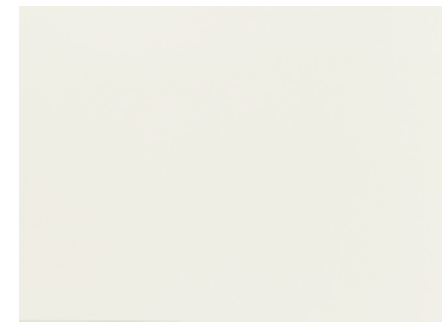

White



Whitened

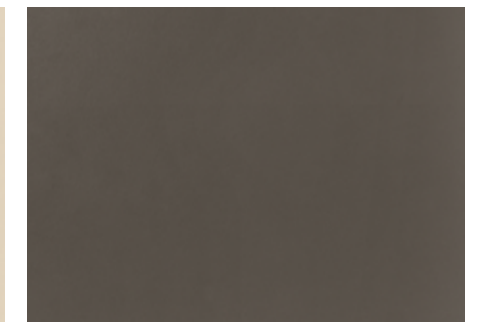

Grey

TABLES FINISHES

HPL SAMPLES

STRIPES
PENDRILLON

*Other colours
available on demand*



0001 0561 0593



0606 0706 1661

TABLES FINISHES

HPL SAMPLES

STRIPES
PENDRILLON

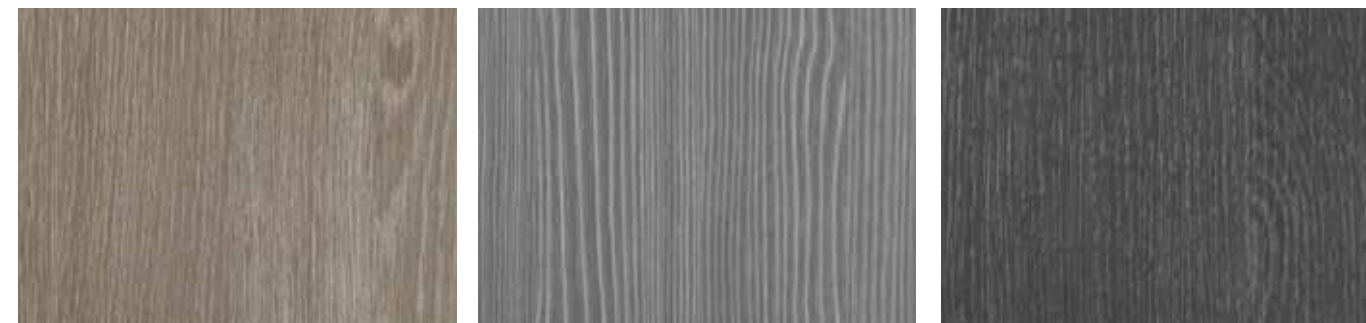

4511 4513 4517



4528 4529 4537

METAL FINISHES

STRIPES
PENDRILLON
ASSEMBLAGE
H&L SOFA



OPM1
Shiny chrome metal



OPM2
Brushed matt chrome metal



OPM3
Brushed matt dark grey metal

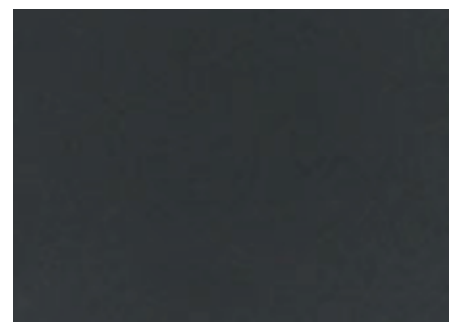

OPM6
RAL 9017 traffic black painted metal



OPM7
RAL 9016 traffic white painted metal

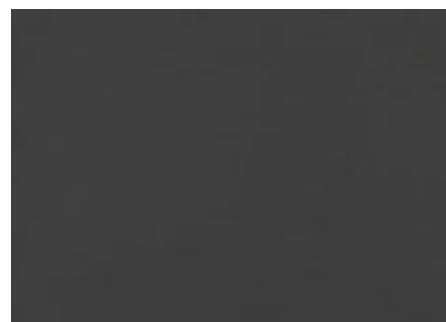

OPM9
Classic bronze painted metal



OPM10
Golden beach painted metal



OPM11
Gold pearl painted metal



OPM12
Brushed copper metal

METAL FINISHES

STRIPES
PENDRILLON
ASSEMBLAGE
H&L SOFA



OPM13
Brushed antique brass metal



OPM14
Shiny black chrome metal



OPM15
Brushed antique gold metal



OPM16
Shiny brass chrome metal



OPM17
Bronze metal



OPM18
Anodized bronze metal



RAL 9006
White aluminium painted metal



OPM8
Metal painted in RAL Classic colours

TABLES FINISHES

OAK SAMPLES

STRIPES
PENDRILLON
ASSEMBLAGE
H&L SOFA
PIVOT



OPR1
Cherry stained oak

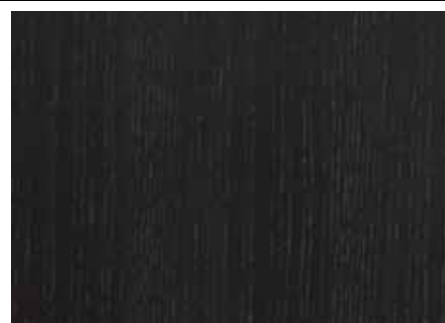

OPR2
Wengé stained oak

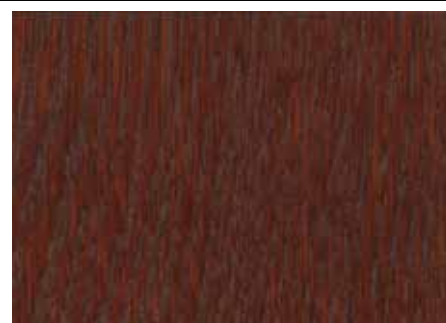

OPR3
Walnut stained oak



OPR4
Natural oak



OPR5
Black stained oak



OPR6
Cherry Milano stained oak

TABLES FINISHES

OAK SAMPLES

STRIPES
PENDRILLON
ASSEMBLAGE
H&L SOFA
PIVOT



OPR8
Tobacco stained oak



OPR9
Grey taupe stained oak



OPR10
Whitened oak



OPR11
Charcoal stained oak



OPR12
Mahogany stained oak



OPR15
Moka matt stained oak



OPR14
Oak painted in RAL Classic colours

MARBLE FINISHES

ASSEMBLAGE
H&L SOFA



OPP1
White Carrara marble



OPP2
Black Marquinia marble



OPP3
Brown Emperador marble



OPP7
Calacatta gold marble



OPP9
Black and gold marble



OPP10
Perfetto brown marble



OPP11
Grey Stone marble



OPP12
Guatemala green marble



OPP13
Velvet brown marble

